

USER MANUAL

METER FOR ELECTRICAL INSTALLATION PARAMETERS

MPI-530 • MPI-530-IT

MPI-530 / MPI-530-IT

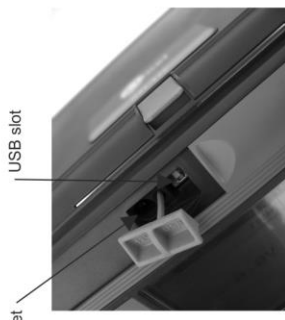

Charger socket

USB slot

ES socket for measuring earth resistance

Measuring terminals

Clamp socket

Charger socket and a USB slot under a sliding flap



Start the measurement procedure

Touch electrode

Confirming the selection

ESC - return to previous function, exit the function

Shift/selection: right / left, up / down

Power on/off

MENU - selection of additional meter's settings

Turning the display backlight on/off

ROTARY SWITCH FOR SELECTING FUNCTIONS:

- - checking the phase sequence, motor rotation direction and measuring light intensity
- R_{Σ} , $R_{\Sigma 0}$ - measuring the resistance of protective conductor and equipotential bonding and low-voltage resistance measurement
- Z_{L-PE} , R_{CD} - measurement of fault loop impedance in L-PE circuit protected with a residual current device (RCD) measurement
- Z_{L-PE} , U_{L-PE} - measurement of fault loop impedance in L-PE circuit
- Z_{N-L-L} , U_{N-L-L} - measurement of fault loop impedance in L-N or L-L circuit
- **AUTO** - RCD: automatic measurement
- $I_{\Delta n}$ - RCD: measurement of tripping current
- t_{RCD} - RCD: response time measurement
- R_E - measurement of resistance to earth
- R_{iso} - measurement of insulation resistance
- **LOGGER** - saving mains parameters
- **MEM** - - browsing and deleting the memory content and data transmission

Display operating keys - correspond to individual fields displayed at the bottom of the screen.

Straps loops



USER MANUAL

METER FOR ELECTRICAL INSTALLATION PARAMETERS MPI-530 • MPI-530-IT



**SONEL S.A.
Wokulskiego 11
58-100 Świdnica
Poland**

Version 2.03 24.08.2021

MPI-530 / MPI-530-IT meter is a modern, easy in use and safe measuring device. Please acquaint yourself with this manual in order to avoid measuring errors and prevent possible problems in operation of the meter.

CONTENTS

1 Safety	6
2 Menu	7
2.1 Wireless transmission	8
2.2 Measurement Settings	8
2.2.1 Earthing system, voltage and frequency	8
2.2.2 Main result of fault loop impedance measurement	9
2.2.3 Measurement settings	10
2.2.4 RCD AUTO measurement mode	10
2.2.5 Cell autoincrementing	11
2.2.6 Resistivity measurement settings	11
2.2.7 Calibration of C-3 clamps	12
2.2.8 Setting limits	12
2.3 Meter Settings	13
2.3.1 LCD contrast	13
2.3.2 LCD Backlight	14
2.3.3 Automatic shut-off (Auto-OFF)	14
2.3.4 Date and time	15
2.3.5 Key sounds	15
2.3.6 Factory (default) settings	16
2.3.7 Software update	16
2.3.8 Wireless communication	16
2.4 Language selection	17
2.5 Information about manufacturer	17
3 Measurements	18
3.1 Diagnostics performed by the meter - limits	18
3.2 Measurement of alternating voltage and frequency	18
3.3 Checking the correctness of PE (protective earth) connections	19
3.4 Measurement of fault loop parameters	20
3.4.1 Measurement of fault loop parameters in the L-N and L-L circuits	20
3.4.2 Measurement of fault loop parameters in the L-PE circuit	23
3.4.3 Measurement of fault loop impedance in L-PE circuit protected with a residual current device (RCD)	25
3.4.4 Prospective short-circuit current	26
3.4.5 MPI-530-IT Measurements in IT networks	27
3.5 Measurement of resistance to earth	28
3.5.1 Measurement of resistance to earth using 3p method	28
3.5.2 Measurement of resistance to earth using 4p method	32
3.5.3 Measurement of resistance to earth using 3p + clamps method	36
3.5.4 Measurement of resistance to earth using double clamp method	40
3.5.5 Measuring soil resistivity	43
3.6 Measurement of RCD parameters	47
3.6.1 Measurement of RCD disconnection current	47
3.6.2 Measurement of RCD disconnection time	50
3.6.3 Automatic measurement of RCD parameters	52
3.6.4 MPI-530-IT Measurements in IT networks	59
3.7 Measurement of insulation resistance	60
3.7.1 Double-lead measurement	60
3.7.2 Measurements by means of leads with UNI-Schuko outlet plug (WS-03 and WS-04)	63

3.7.3	Measurements with AutoISO-1000c adapter	66
3.8	Low-voltage measurement of resistance	70
3.8.1	Measurement of resistance of protective conductors and equipotential bonding with ± 200 mA current.....	70
3.8.2	Measurement of resistance	73
3.8.3	Compensation of test leads resistance	74
3.9	Checking sequence of phases	75
3.10	Checking the motor rotation direction.....	77
3.11	Light measurements.....	78
3.12	Recorder. Measurement and recording of current, voltage, $\cos\phi$, PF factor, harmonics and THD.....	80
4	Memory of measurement results	84
4.1	Structure of the Memory.....	84
4.1.1	The appearance of main windows in the measurement recording mode.....	85
4.2	Storing the measurement results data in the memory.....	87
4.2.1	Entering the results without extending the memory structure.....	87
4.2.2	Extending the memory structure.....	88
4.3	Browsing and editing the memory	93
4.4	Browsing the recorder memory	95
4.5	Deleting memory data	98
5	Data transmission	100
5.1	Set of accessories to connect the meter to a PC	100
5.2	Data transmission through USB port.....	100
5.3	Connecting to Bluetooth mini-keyboard.....	100
5.3.1	Manual connection	100
5.3.2	Automatic connection.....	102
5.4	Data transmission using Bluetooth module	102
5.5	Read-out and change of PIN code for Bluetooth connections.....	103
6	Power supply of the meter	105
6.1	Monitoring the power supply voltage.....	105
6.2	Replacing batteries (rechargeable batteries)	105
6.3	Charging rechargeable batteries	106
6.4	General principles for using Ni-MH rechargeable batteries.....	107
7	Cleaning and maintenance.....	108
8	Storage	108
9	Dismantling and utilisation	109
10	Technical specifications.....	109
10.1	Basic data.....	109
10.2	Other technical data	119
10.3	Additional data.....	119
10.3.1	Additional uncertainties according to IEC 61557-2 (R_{ISO})	119
10.3.2	Additional uncertainties according to IEC 61557-3 (Z).....	120
10.3.3	Additional uncertainties according to IEC 61557-4 ($R \pm 200$ mA)	120
10.3.4	Additional uncertainties of earth resistance measurement (R_E)	120
10.3.5	Additional uncertainties according to IEC 61557-6 (RCD)	121
10.4	List of reference standards.....	121

11 Accessories..... 122
 11.1 *Standard accessories* 122
 11.2 *Optional accessories*..... 123
 11.2.1 *Clamps C-3*..... 126
 11.2.2 *Clamps C-6*..... 127
 11.2.3 *Clamps F-1, F-2, F-3*..... 128
 11.2.4 *Clamps N-1*..... 129
12 Positions of the meter's cover..... 130
13 Manufacturer 130
14 Laboratory services..... 131

1 Safety

MPI-530 / MPI-530-IT meter is designed for performing check tests of protection against electric shock in AC mains systems. The meter is used for making measurements and providing results to determine safety of electrical installations. Therefore, in order to provide conditions for correct operation and accuracy of obtained results, the following recommendations must be observed:

- Before you proceed to operate the meter, acquaint yourself thoroughly with the present manual and observe the safety regulations and specifications provided by the producer.
- Any application that differs from those specified in the present manual may result in a damage to the device and constitute a source of danger for the user.
- MPI-530 / MPI-530-IT meters must be operated only by appropriately qualified personnel with relevant certificates authorising the personnel to perform works on electric systems. Operating the meter by unauthorised personnel may result in damage to the device and constitute a source of danger for the user.
- Using this manual does not exclude the need to comply with occupational health and safety regulations and with other relevant fire regulations required during the performance of a particular type of work. Before starting the work with the device in special environments, e.g. potentially fire-risk/explosive environment, it is necessary to consult it with the person responsible for health and safety.
- It is unacceptable to operate:
 - ⇒ a damaged meter which is completely or partially out of order,
 - ⇒ a meter with damaged insulation,
 - ⇒ a meter stored for an excessive period of time in disadvantageous conditions (e.g. excessive humidity). If the meter has been transferred from a cool to a warm environment with a high level of relative humidity, do not start measurements until the meter is warmed up to the ambient temperature (approximately 30 minutes).
- Displayed **BAT!** symbol indicates insufficient voltage of power supply and the need to charge the accumulator or replace batteries. All measurements except voltage measurements for Z and RCD functions are blocked.
- Battery spill and damage to the meter may occur if discharged batteries are left in the meter.
- Before measurements may commence, make sure the leads are connected to the appropriate measurement sockets.
- Do not operate a meter with an open or incorrectly closed battery (accumulator) compartment or power it from other sources than those specified in the present manual.
- **R_{iso}** meter inputs are electronically protected against overloads (caused by e.g. connecting the meter to a live circuit) up to 440V rms for 60 seconds.
- Repairs may be performed only by an authorised service point.

ATTENTION!

Only standard and additional accessories for a given device should be used, as listed in the "Equipment" section. Using other accessories may cause damage to measuring terminals, introduce additional measurement uncertainty and create a risk for the user.

Note:

Due to continuous development of the meter's software, the actual appearance of the display, in case of some of the functions, may slightly differ from the display presented in this operating manual.

Note:

An attempt to install drivers in 64-bit Windows 8 may result in displaying "Installation failed" message.

Cause: Windows 8 by default blocks drivers without a digital signature.

Solution: Disable the driver signature enforcement in Windows.

2 Menu

The Menu is accessible in each position of the rotary switch.

1



Press **MENU** push-button.



The main menu contains the following items:

- Wireless transmission
- Measurement Settings
- Meter Settings
- Language selection
- Information about manufacturer

2

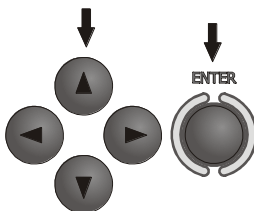

Use ▲, ▼ and ◀, ▶ to select desired position. Enter a selected option by pressing **ENTER**.

2.1 Wireless transmission

See section 5.3.

2.2 Measurement Settings

1

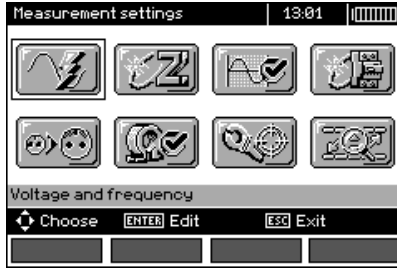

The option of **Measurement settings** consists of:

- Voltage and frequency
- The main result for fault loop
- Assessing fault loop measurement
- Measurement settings
- RCD AUTO measurement mode
- Cell autoincrementing
- Resistivity measurement settings
- Calibration of C-3 clamps
- Setting limits

2

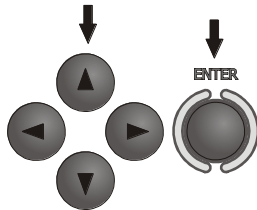

Use ▲, ▼ and ◀, ▶ to select desired position. Enter a selected option by pressing **ENTER**.

2.2.1 Earthing system, voltage and frequency

Before first measurements, select earthing system used in the area where measurements are performed. Then select the mains rated voltage U_n (110/190 V, 115/200 V, 127/220 V, 220/380 V, 230/400 V or 240/415 V). This voltage value is used for calculating the values of prospective short-circuit current.

Determination of network frequency, that is the source of potential interferences, is necessary in order to select a proper measuring signal frequency in resistance-to-earth measurements. Only the measurement conducted with a properly selected frequency of measuring signal will ensure optimum filtration of interferences. The meter is designed for filtration of interferences generated by 50 Hz and 60 Hz networks.

1

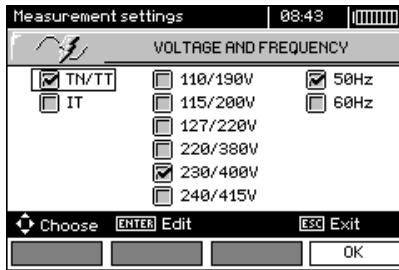

2

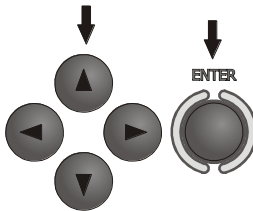

Use ◀, ▶ and ▲, ▼ to select the voltage and frequency. Press **ENTER** to select the desired item. Press **F4** (OK) to approve the selection.

2.2.2 Main result of fault loop impedance measurement

1

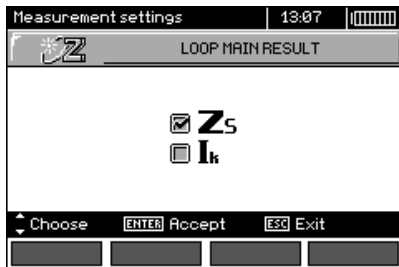

2

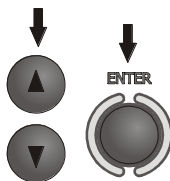

Use ▲, ▼ to select the main result as Z_s impedance or as I_k - prospective short-circuit current and press **ENTER** to confirm your selection.

2.2.3 Measurement settings

The setting enables activation/deactivation of the field displaying measurement settings. Use ▲ and ▼ to display or hide the field with measurement settings and press **ENTER**.

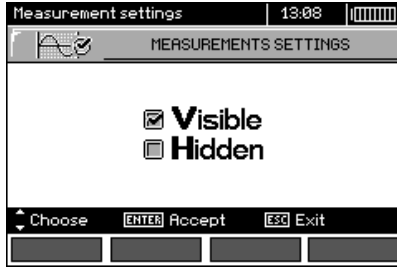

Displayed measurement settings



Hidden measurement settings

2.2.4 RCD AUTO measurement mode

This setting enables user to select desired measurement mode of RCD AUTO. Use ▲ and ▼ to select desired mode and press **ENTER**.

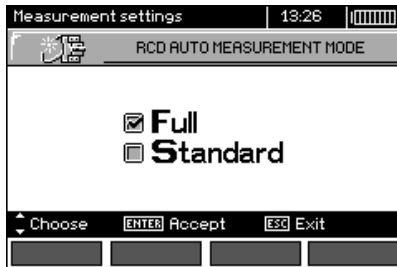

In the standard mode, measurements are performed for a selected current waveform, in the full mode for all current waveforms of a given type of RCD (AC, A, B, B+, F).

2.2.5 Cell autoincrementing

1

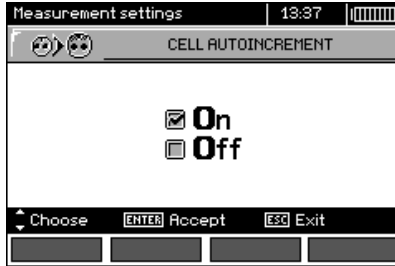

2

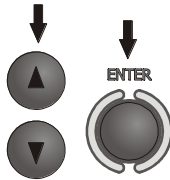

Use ▲, ▼ to select automatic or manual incrementing of field number after entering it to the memory (automatic incrementing is deactivated), press **ENTER** to approve the selection.

2.2.6 Resistivity measurement settings

1

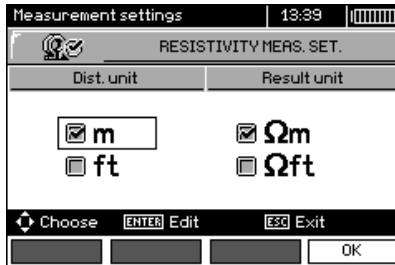

2

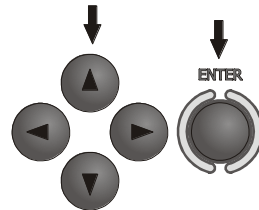

Use ▲, ▼ and ◀, ▶ to select length unit and result unit, press **ENTER** to mark your choice.

3



Press **F4** to approve the selection.

2.2.7 Calibration of C-3 clamps

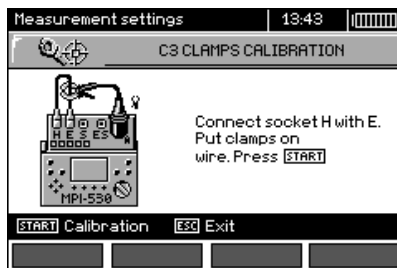

2.2.8 Setting limits

①

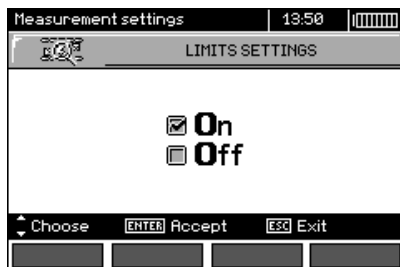

②

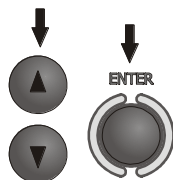

Use ▲, ▼ to switch on/off the function of setting limits, press **ENTER** to confirm.

Note:

- Detailed description of the diagnostics functions (including application of limit values) carried by the meter is described in chapter 3.1.

2.3 Meter Settings

The option of **Meter Settings** consists of:

- LCD contrast
- LCD Backlight
- Automatic shut-off
- Date and time
- Key sounds
- Factory (default) settings
- Updating the meter
- Wireless communication

①

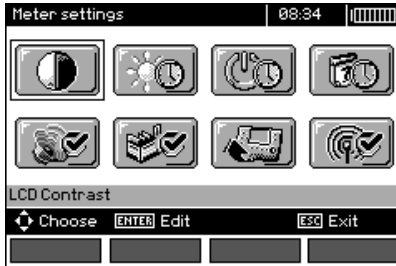

②

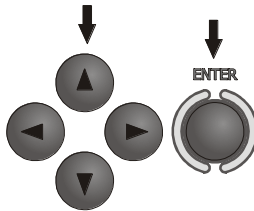

Use ▲, ▼ and ◀, ▶ to select desired position and press **ENTER** to edit selected option.

2.3.1 LCD contrast

①

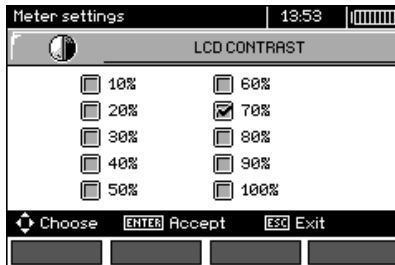

②

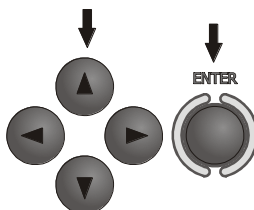

Use ▲, ▼ and ◀, ▶ to adjust contrast; press **ENTER** to confirm.

2.3.2 LCD Backlight

This setting defines the time for automatic backlight shut-off: 30 s, 60 s, or disabled.

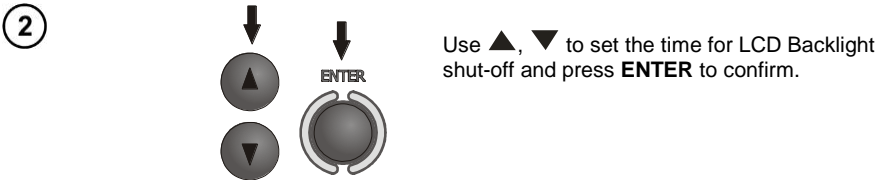
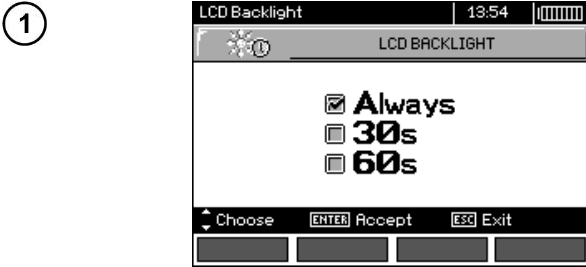

2.3.3 Automatic shut-off (Auto-OFF)

The setting defines the shut-off time of idle meter.

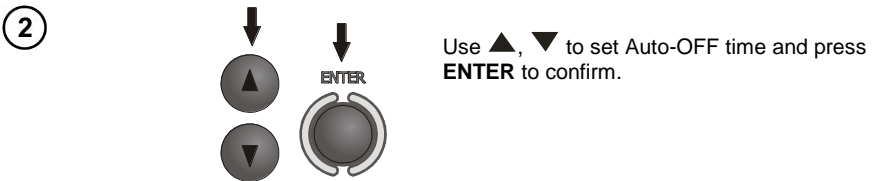
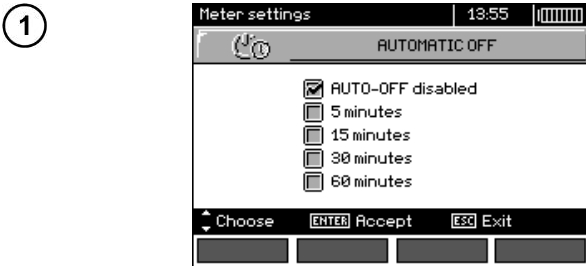

2.3.4 Date and time

1

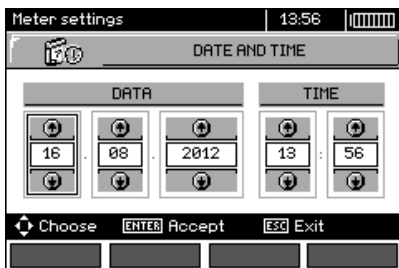

2

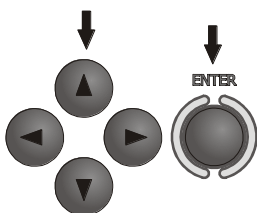

Use ◀, ▶ to select the value to be changed (day, month, year, hour, minute)
Use ▲, ▼ to set the desired value.
When required settings are made, press ENTER.

2.3.5 Key sounds

1

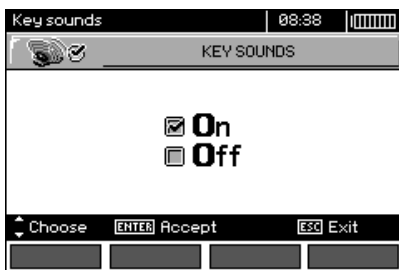

2

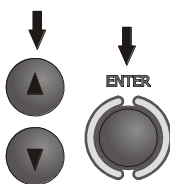

Use ▲, ▼ buttons to switch-off sound signals assigned to push buttons.

Note:

- Warning sound signals: U>440V, U>50V, Rbeep, PE!, cannot be switched-off, they remain constantly active.

2.3.6 Factory (default) settings

1

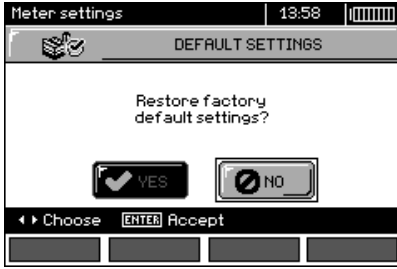

2

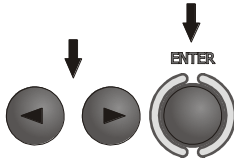

In order to return to factory (default), use ◀▶ to select YES and press ENTER.

2.3.7 Software update

ATTENTION!
A new battery pack should be installed or rechargeable batteries should be recharged before programming.
During programming the meter must not be switched off as well as the transmission cable must not be disconnected.

Before updating software, download the software from the manufacturer's website (www.sonel.pl) and install it on your PC, then connect the meter to PC.

Select **Software upgrade** in the MENU and follow the instructions displayed by the program.

2.3.8 Wireless communication

1

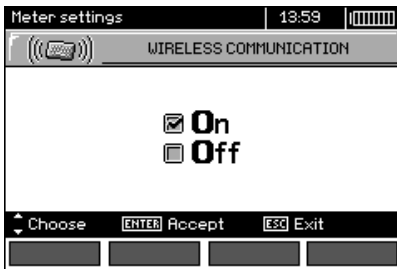

2

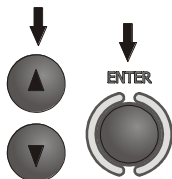

Use ▲, ▼ to select the wireless communication ON/OFF and press **ENTER** to confirm.

2.4 Language selection

1



2

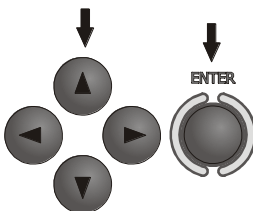

Use ◀, ▶ and ▲, ▼ to select desired language and press **ENTER**.

2.5 Information about manufacturer

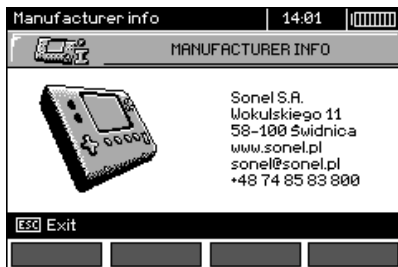

3 Measurements

Note:

- A progress bar is displayed during long measurements.
- The content of this chapter should be thoroughly familiarized with since it describes the meter circuits, the methods of measurements and basic principles concerning interpretation of measurement results.
- Result of the latest measurement is remembered by the meter until a next measurement is started or measurement settings are changed or the measuring function is changed by means of the rotary switch or the meter is switched off. It is displayed for 20 s. Then it may be recalled by pressing **ENTER**.

WARNING:

During measurements (fault loop, RCD), do not touch earthed and accessible parts of the tested electrical installation.



WARNING:

During a measurement, switching of the range switch is forbidden because it may damage the meter and pose a threat to the user.

3.1 Diagnostics performed by the meter - limits

The meter is able to assess whether the measurement result is within acceptable limits for the selected safety device or the limit value. The user may set a limit, i.e. maximum or minimum value, which should not be exceeded by the result. It is possible for all measurement functions except RCD measurements for which limits are set and permanently active and for the recorder function. For measurements of insulation resistance and light, the set limit is the minimum value, whereas for the following measurements: fault loop impedance, earth resistance, resistance of protective conductors and equipotential bonding - it is the maximum value.

The limits are activated globally in the main menu (Section 2.2.9). When the function of setting limits is activated, the display, in its upper right corner, shows the symbols with the following meaning:

- : the result is correct, it is within the set limits,
- : the result is incorrect, it is outside the set limits,
- : the correctness of the result cannot be assessed: this symbol is displayed, when for example the result is not available (e.g. measurement in progress, or no measurement has been performed)

The method for setting limits is described in the chapters describing the measurement data. It should be noted that for the fault loop the limit is determined indirectly by selecting a suitable overcurrent protection for which standard limits are assigned.

3.2 Measurement of alternating voltage and frequency

The meter measures and displays alternating voltage and frequency of the network in all measuring functions except R_E , R_X , $R_{\pm 200mA}$, $R_{ISO-conductor}$. For $w_{(LUX)}^v$ function (phase sequence) and R_{ISO} voltage is displayed without frequency. This voltage is measured for the frequencies within the range of 45...65 Hz as True RMS. If the measured frequency is outside the specified range, the following message is displayed instead of the frequency value: **f<45Hz** or **f>65Hz**. Voltage is displayed as the main result only for $U_{L-N,L-L}$, $Z_{L-N,L-L}$, U_{L-PE} Z_{L-PE} and **LOGGER**. The test leads should be connected as for a given measuring function.

3.3 Checking the correctness of PE (protective earth) connections

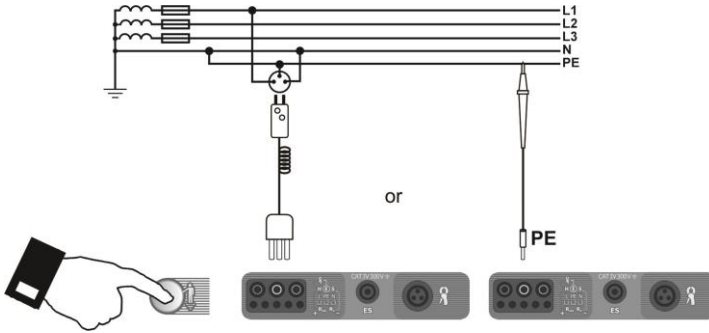

After connecting the meter according to the drawing, touch the contact electrode with a finger and wait for about 1 second. When voltage is found on PE the meter displays **PE!** symbol (error in the installation; PE connected to the phase conductor) and generates a continuous beep. This option is available for all measuring functions that apply to residual current devices (RCD) and fault loop.

Note:

WARNING:
When phase voltage is detected on PE lead, measurements must be immediately stopped and a fault in the installation must be removed.

- The person making a measurement must ensure that he/she is standing on a non-insulated floor during the measurement; otherwise the result of the measurement may be incorrect.
- The threshold value, which triggers the signal of exceeded allowable voltage on PE conduit, is approximately 50 V.

3.4 Measurement of fault loop parameters



If there are residual current devices in the network tested, they should be bypassed by bridging for the period of impedance measurement. However, it should be remembered that the tested circuit is modified in this way and the obtained results may slightly differ from the actual results.

After completing measurements, always remove modifications introduced to the tested system for the period of measurements and check the operation of the residual current switch.

The above remark does not apply to measurements of fault loop impedance with the use of Z_{L-PE} **RCD** function.



Measurements of fault loop impedance performed downstream of inverters are ineffective and their results are unreliable. This is due to the instability of internal impedance in inverter circuits during its operation. The measurements of fault loop impedance should not be performed directly downstream of inverters.

3.4.1 Measurement of fault loop parameters in the L-N and L-L circuits

Settings

①

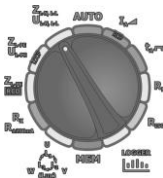

Set the rotary switch of function selection at $Z_{L-N,L-L}/U_{L-N,L-L}$ position.

②

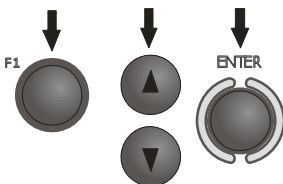

Press **F1** **WIRE** push-button if L lead length needs to be selected. Use **▲** and **▼** to select the lead length and press **ENTER**.



3

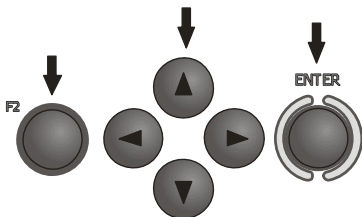

In order to set the security parameters press **F2** .

Use **←**, **→** and **▲**, **▼** to set the security parameters and press **ENTER**.

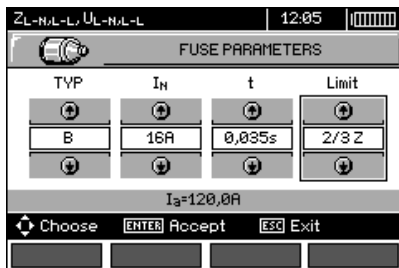

The symbols displayed on the above screen have the following meaning:

TYPE - type of security

I_N - rated security current

t - response time

Limit - a limit resulting from a standard (when selecting **2/3Z** I_a it is increased by 1/2I_a, when selecting --- I_a it is as stated in the tables of the standard - without correction)

I_a - current ensuring automatic triggering of a protective device in a required time, determined automatically basing on pre-set parameters of security settings

4

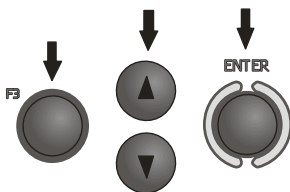

In order to select the voltage for calculating the prospective short circuit current I_k - nominal or measured - press **F3** .

Use **▲**, **▼** to select desired voltage and press **ENTER**.



Measurement

5

Connect test leads according to the drawing
 a) for measurement in L-N circuit or
 b) for measurement in L-L circuit

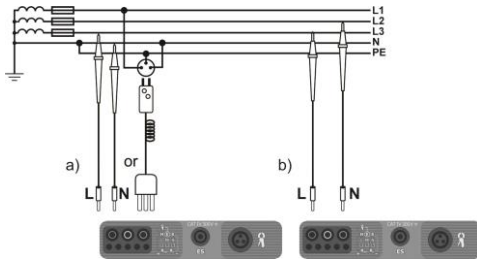

6

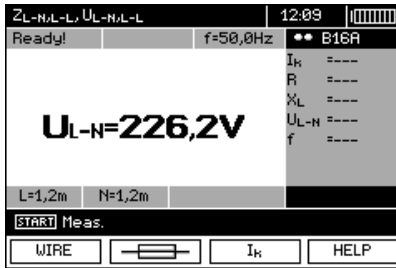

The meter is ready for measurement.

7

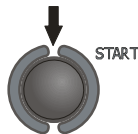

Make measurement by pressing **START** push-button.

8

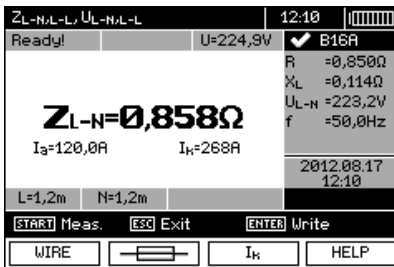

Read out the result:
 Z_{L-N} - the main result
 I_a - current ensuring automatic triggering of a selected protective device in a required time
 I_k - prospective short-circuit current
 R , X_L , U_{L-N} , f - additional results.

The result is displayed on the screen for 20 s.
 The result can be recalled by pressing **ENTER** push-button.



Note:

- The result may be entered into the memory (see sec. 4.2).
- When many measurements are made in short time intervals, the meter may emit a large amount of heat. As a result of this, the housing of the device may become hot. This is normal and the meter is equipped with the protection against excessive temperature. After approximately 15 consecutive

measurements of short circuit loop, wait until the instrument cools down. This limitation results from the high current measurement and multi-functionality of the meter.

- Minimum interval between successive measurements is 5 seconds. This minimum interval requirement is controlled by the meter. The next measurement may be performed only when **READY!** message appears on the screen. Until the message is displayed - the meter prevents any measurements.

Additional information displayed by the meter

READY!	The meter is ready for measurement.
L-N!	U_{L-N} voltage is incorrect for making a measurement.
L-PE!	U_{L-PE} voltage is incorrect for making a measurement.
N-PE!	U_{N-PE} voltage exceeds allowable value of 50V.
	Phase connected to N terminal instead of L terminal (for example, exchange of L and N in the mains socket).
	Temperature exceeded.
f!	Network frequency is outside the range of 45 Hz ...65 Hz.
Error during measurement	Correct result cannot be displayed.
Loop circuit malfunction!	The meter should be serviced.
No U_{L-N}!	Lack of U_{L-N} voltage before the main measurement.
U>500 V! and continuous audio signal	Before measurement, voltage at test terminals exceeds 500 V.
LIMIT	Too low value of the prospective short circuit current I_k for the pre-set security and time of its triggering.

3.4.2 Measurement of fault loop parameters in the L-PE circuit

Settings

1

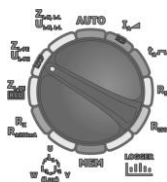

Set the rotary switch of function selection at **Z_{L-PE}/U_{L-PE}** position.

2

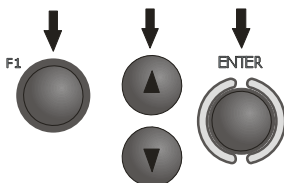

Press **F1**  push-button if L lead length needs to be selected. Use **▲** and **▼** to select the lead length and press **ENTER**.

3

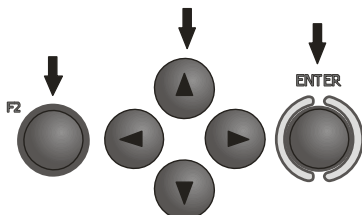

In order to set the security parameters press **F2** . Use **◀**, **▶** and **▲**, **▼** to set the security parameters and press **ENTER**.

Measurement

4

Connect test leads according to one of the following drawings.

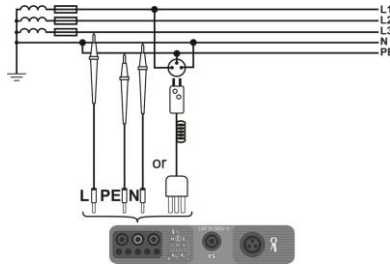

Measurement in L-PE circuit

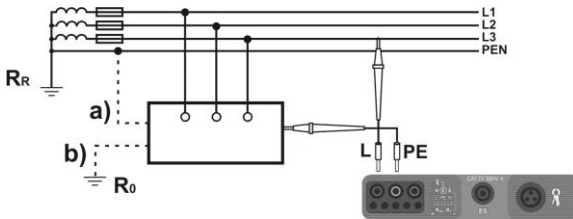

Checking effectiveness of protection against electric shock of the housing in case of: a) TN b) TT.

5

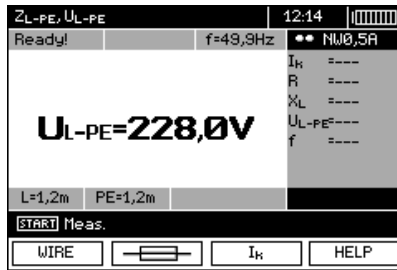

The meter is ready for measurement.

6

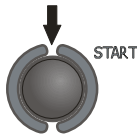

Make measurement by pressing **START** push-button.

7

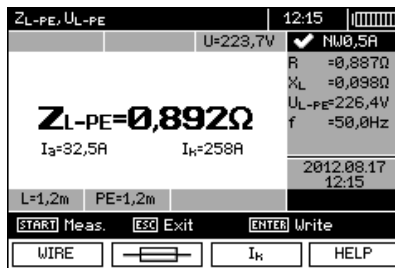

Read out the result:
 Z_{L-PE} - the main result
 I_a - current ensuring automatic triggering of a selected protective device in a required time
 I_k - prospective short-circuit current
 R, X_L, U_{L-PE}, f - additional results.

The result is displayed on the screen for 20 s.
 The result can be recalled by pressing **ENTER** push-button.

Note:

- Maximum measurement time is about 32 seconds. The measurement can be interrupted by pressing **ESC** push-button.
- In the electrical installations with 30 mA RCD's, the sum of leakage currents of the installation and the test current may trigger the RCD. If this happens, try to reduce the leakage current in the tested mains (for example by disconnecting loads).
- Remaining issues connected with the measurements as well as the messages displayed are the same as those described for measurements L-PE circuit.
- The function works for residual current devices of nominal current ≥ 30 mA.

Additional information displayed by the meter

Voltage absence (e.g. N <-> PE)	Voltage absence during the measurement. The N and PE wires of the installation may be connected to the mains socket in reverse.
--	---

3.4.4 Prospective short-circuit current

The meter always measures impedance Z_S . The short-circuit current is calculated according to the following formula:

$$I_k = \frac{U}{Z_S}$$

where: Z_S - measured impedance, U - voltage that depends on settings of I_k button, according to the following Table:

The selection in MENU	
$I_k(U_n)$	$U = U_n$
$I_k(U_0)$	$U = U_0$ for $U_0 < U_n$
	$U = U_n$ for $U_0 \geq U_n$

where: U_n - nominal voltage of the network, U_0 - the voltage during the measurement.

On the basis of U_n rated voltage selected (section 2.2.1), the meter automatically recognizes the measurement at phase-to-neutral or phase-to-phase voltage and takes it into account in the calculations.

If the voltage of the network being tested is outside the tolerance range, the meter will not be able to determine a proper rated voltage for the short-circuit current calculation. In such a case, horizontal dashes will be displayed instead of short-circuit current value. The following diagram shows voltage ranges for which short-circuit current value is calculated.

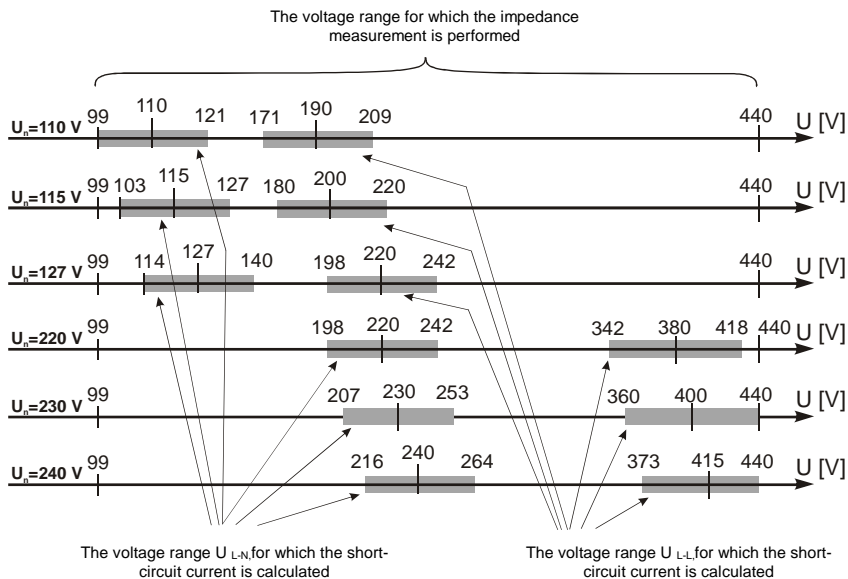

3.4.5 MPI-530-IT Measurements in IT networks

Before making measurements, the proper network type (earthing system) shall be set in main menu of the meter, see point 2.2.1.

WARNING:
 When IT network type (IT system) is chosen, touch electrode on the meter is disabled.

Connection of the meter to installation is show on the drawing below.

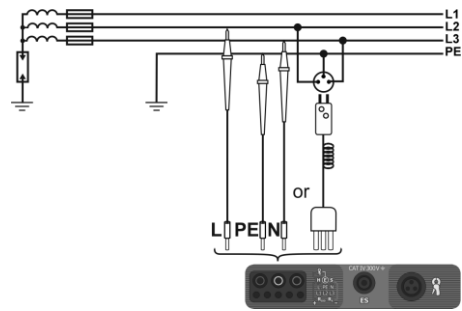

The way of making short circuit loop measurements is described in point 3.4.1. Operating voltage range: 95 V ... 440 V.

3.5 Measurement of resistance to earth

3.5.1 Measurement of resistance to earth using 3p method

The three-lead measuring method is the basic type of resistance-to-earth measurement.

1

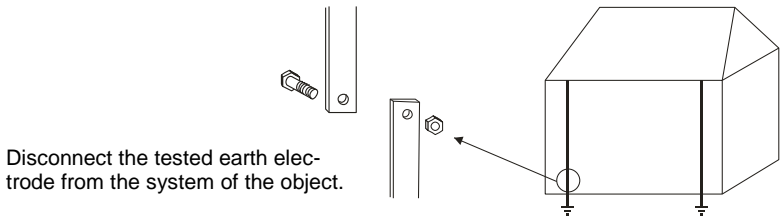

2

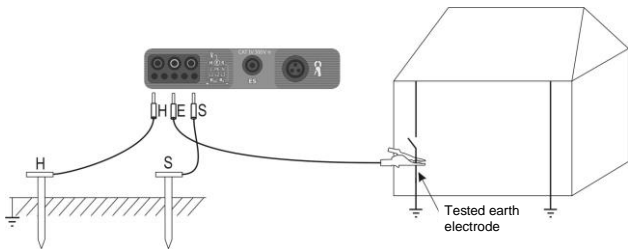

The current electrode (driven into earth) should be connected to **H** socket of the meter.
 The voltage electrode (driven into earth) should be connected to **S** socket of the meter.
 The earth electrode being tested should be connected to **E** socket of the meter.
 The tested earth electrode as well as current and voltage electrodes should be located along one line and in the relevant distances, in accordance with the rules of earth measurements.

Settings

3

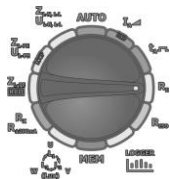

Turn the rotary switch to R_E position.

4



To select the measurement method press **F2** **MODE**.

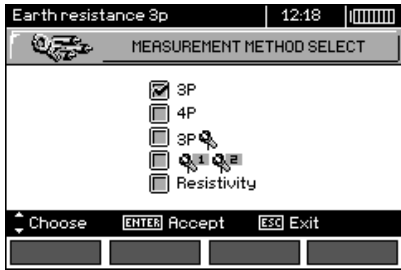

5

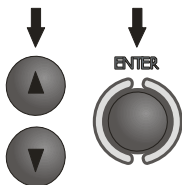

Use ▲ and ▼ to select **3P**, confirm by pressing **ENTER**.

6

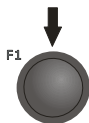

To change the measuring voltage press **F1** .

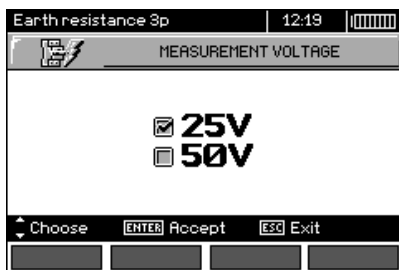

7

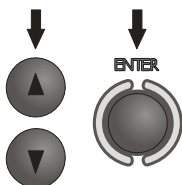

Use ▲ and ▼ to select the measuring voltage, confirm by pressing **ENTER**.

8



In order to set the limit (maximum resistance) press **F3** .

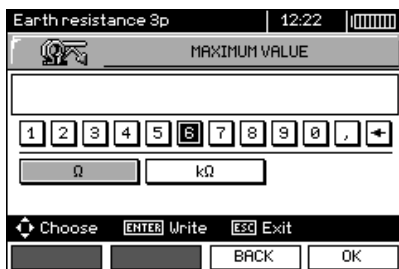

9

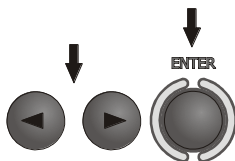

Use ◀, ▶ and ENTER to enter the resistance value.

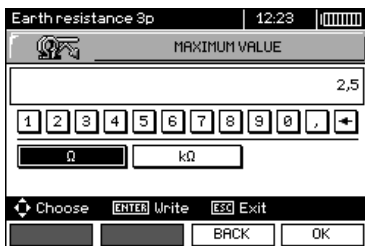

10

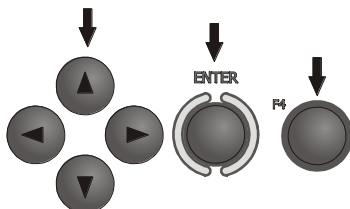

Use ◀, ▶, ▲, ▼ and ENTER to select unit, confirm by pressing F4 OK.

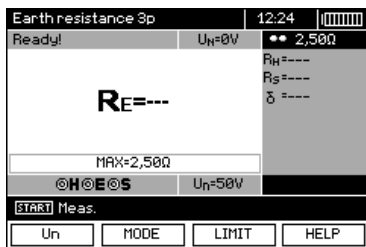

The meter is ready for measurement. Value of interference voltage U_N of the measured object may be read on the display.

Measurement

11

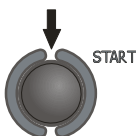

Press **START** push-button to start the measurement.

12

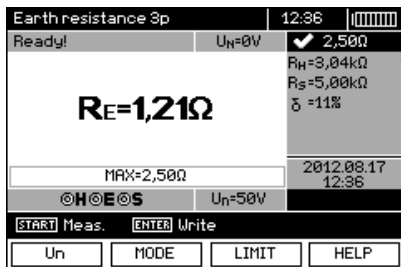

Read out the result.

- ← Resistance of current electrode
- ← Resistance of voltage electrode
- ← The value of additional uncertainty, generated by the resistance of auxiliary electrodes

The result is displayed on the screen for 20 s. The result can be recalled by pressing **ENTER** push-button.

13

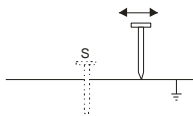

Repeat the measurements (steps 2, 11, 12) moving the voltage a few meters - placing it farther and closer to the measured earth electrode. If R_E measurement results differ from one another by more than 3 %, the distance of the current electrode from the earth electrode being tested should be considerably increased and the measurements should be repeated.



Note:



Measurement of resistance-to-earth may be carried out if voltage of interferences does not exceed 24 V. Voltage of interferences is measured up to the level of 100 V, but above 50 V it is signalled as dangerous. The meter must not be connected to voltages exceeding 100 V.

- Particular attention should be paid to quality of connection between the object being tested and the test lead – the contact area must be free from paint, rust, etc.
- If resistance of test probes is too high, R_E earth electrode measurement will be burdened with additional uncertainty. Particularly high uncertainty of measurement occurs when a small value of resistance-to-earth is measured with probes that have a weak contact with earth (such a situation occurs frequently when the earth electrode is well made and the upper soil layer is dry and slightly conductive). In such a case, the ratio of resistance of the probes to resistance of the tested earth electrode is very high and consequently, uncertainty of measurement that depends on this ratio is also very high. The uncertainty is displayed on the screen in the column of additional results. In order to reduce the uncertainty, it is recommended to improve the contact between the probe and soil, for example, by dampening with water the place where the probe is driven into earth, driving the probe into earth in a different place or using a 80 cm-long probe. Check also the test leads for possible insulation damage and for corroded or loosened connection between the banana plug and the test lead. In majority of cases the achieved measurement accuracy is satisfactory. However, you should always be aware of the uncertainty included in the measurement.

Additional information displayed by the meter

$R_E > 1.99 \text{ k}\Omega$	Measuring range is exceeded.
 U_N	Voltage at test terminals is higher than 24 V but lower than 50 V, measurement is blocked.
$U_N > 50V!$ and continuous, modulated audio signal	Voltage at test terminals is higher than 50 V.
NOISE!	Signal / noise ratio is too low (interfering signal too large).
LIMIT!	Error due to the resistance of electrodes > 30 % (for calculating uncertainty, measured values are taken into account).
	Interruption in measuring circuit or resistance of test probes is higher than 60 kΩ.
Electrode resistance > 50 kΩ	Resistance of electrodes within the range of 50...60 kΩ.
ABORTED	Measurement has been interrupted with ESC key button.

3.5.2 Measurement of resistance to earth using 4p method

Four-pole method is recommended for use in the measurement of earth resistance of very small values. It allows user to eliminate the influence of resistance of test leads on the measurement results. To determine the soil resistivity, it is recommended to use a function dedicated for this measurement (section 3.5.5).

1

Disconnect the tested earth electrode from the system of the object.

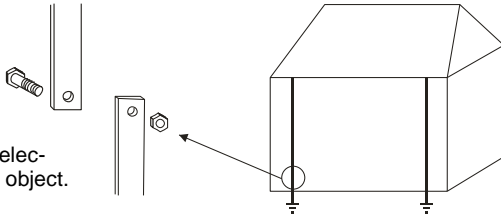

2

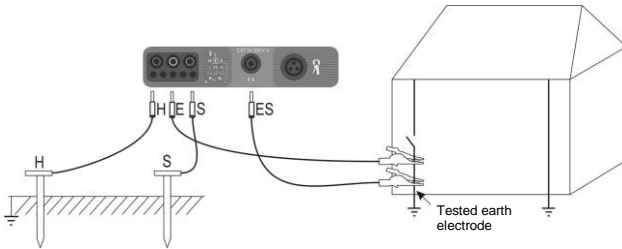

The current electrode (driven into earth) should be connected to **H** socket of the meter. The voltage electrode (driven into earth) should be connected to **S** socket of the meter. The earth electrode being tested should be connected to **E** socket of the meter with the lead. **ES** socket should be connected to the tested earth electrode below **E** lead. The tested earth electrode as well as current and voltage electrodes should be located along one line and in the relevant distances, in accordance with the rules of earth measurements.

Settings

3

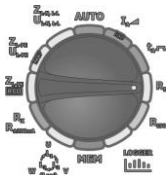

Set the rotary switch of function selection at **Re** position.

4



To select the measurement method press **F2** **MODE**.



5

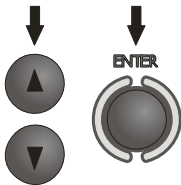

Use ▲ and ▼ to select **4P**, confirm by pressing **ENTER**.

6

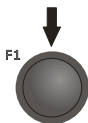

To change the measuring voltage, press **F1** .

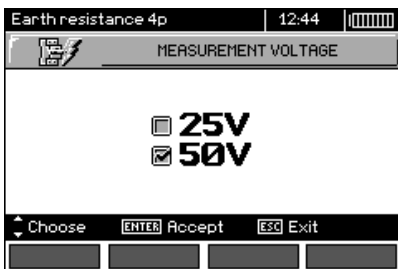

7

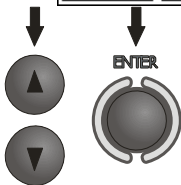

Use ▲ and ▼ to select the measuring voltage, confirm by pressing **ENTER**.

8



In order to set the limit (maximum resistance), press **F3** .

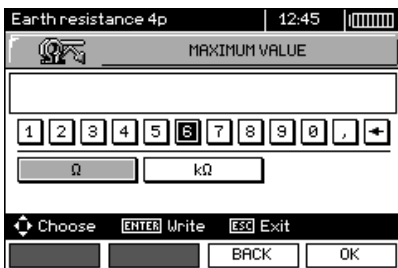

9

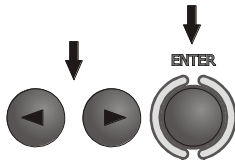

Use \leftarrow , \rightarrow and **ENTER** to enter the resistance value.

10

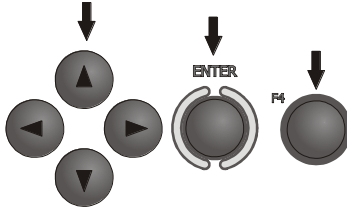

Use \leftarrow , \rightarrow , \uparrow , \downarrow and **ENTER** to select unit. confirm by pressing **F4** **OK**.

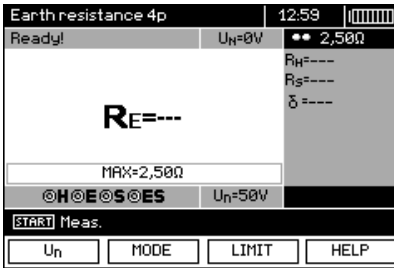

The meter is ready for measurement.
Value of interference voltage U_N of the measured object may be read on the display.

Measurement

11

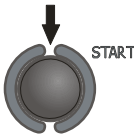

Press **START** push-button to start the measurement.

12

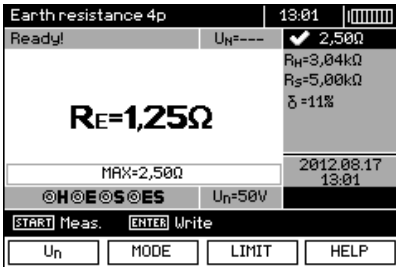

Read out the result.

- \leftarrow Resistance of current electrode
- \leftarrow Resistance of voltage electrode
- \leftarrow The value of additional uncertainty, generated by the resistance of auxiliary electrodes

The result is displayed on the screen for 20 s.
The result can be recalled by pressing **ENTER** push-button.

13

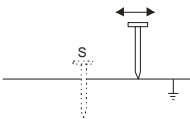

Repeat the measurements (steps 2, 11, 12) moving the voltage a few meters - placing it farther and closer to the measured earth electrode. If R_E measurement results differ from one another by more than 3 %, the distance of the current electrode from the earth electrode being tested should be considerably increased and the measurements should be repeated.



Note:



Measurement of resistance-to-earth may be carried out if voltage of interferences does not exceed 24 V. Voltage of interferences is measured up to the level of 100 V, but above 50 V it is signalled as dangerous. The meter must not be connected to voltages exceeding 100 V.

- Particular attention should be paid to quality of connection between the object being tested and the test lead – the contact area must be free from paint, rust, etc.
- If resistance of test probes is too high, R_E earth electrode measurement will be burdened with additional uncertainty. Particularly high uncertainty of measurement occurs when a small value of resistance-to-earth is measured with probes that have a weak contact with earth (such a situation occurs frequently when the earth electrode is well made and the upper soil layer is dry and slightly conductive). In such a case, the ratio of resistance of the probes to resistance of the tested earth electrode is very high and consequently, uncertainty of measurement that depends on this ratio is also very high. Then, you can make a calculations according to the formulas given in sec. 10.2 to estimate the influence of measurement conditions or you can use the graph also included in the appendix. You can improve the contact between the probe and soil, for example, by dampening with water the place where the probe is driven into earth, driving the probe into earth in a different place or using a 80 cm-long probe. Check also the test leads for possible insulation damage and for corroded or loosened connection between the banana plug and the test lead. In majority of cases the achieved measurement accuracy is satisfactory. However, you should always be aware of the uncertainty included in the measurement.

Additional information displayed by the meter

$R_E > 1,99 \text{ k}\Omega$	Measuring range is exceeded.
$U_N > 50\text{V!}$ and continuous, modulated audio signal 	Voltage at test terminals is higher than 50 V, measurement is blocked.
 U_N	Voltage at test terminals is higher than 24 V but lower than 50 V, measurement is blocked.
LIMIT!	The uncertainty due to the resistance of electrodes > 30 %. (For calculating uncertainty, measured values are taken into account.)
NOISE!	The interfering signal (noise signal) is too high - the measurement result may be affected by additional uncertainty.

3.5.3 Measurement of resistance to earth using 3p + clamps method

1

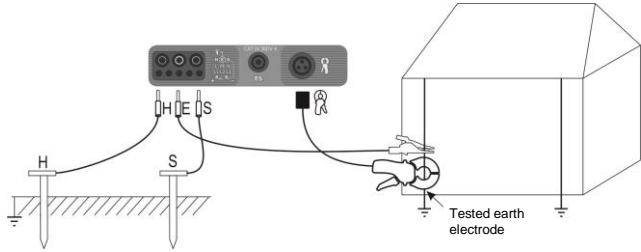

The current electrode (driven into earth) should be connected to **H** socket of the meter. The voltage electrode (driven into earth) should be connected to **S** socket of the meter. The earth electrode being tested should be connected to **E** socket of the meter with the lead. The tested earth electrode as well as current and voltage electrodes should be located along one line and in the relevant distances, in accordance with the rules of earth measurements. Clamps should be attached to the tested earth electrode below the connection point of **E** lead.

Settings

2

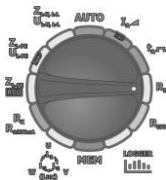

Set the rotary switch of function selection at **RE** position.

3



To select the measurement method press **F2** MODE.

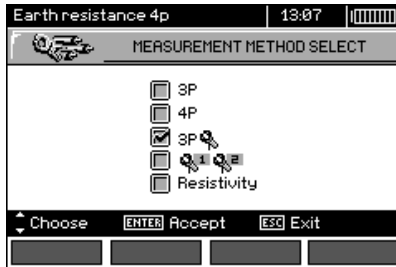

4

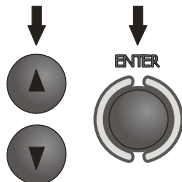

Use **▲** and **▼** to select **3P**, confirm by pressing **ENTER**.

5

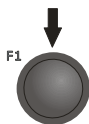

To change the measuring voltage, press **F1** Un.

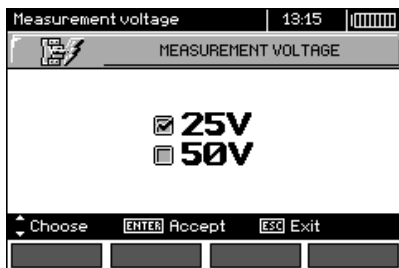

6

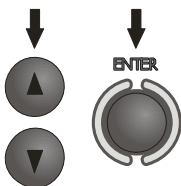

Use ▲ and ▼ to select the measuring voltage, confirm by pressing **ENTER**.

7



In order to set the limit (maximum resistance), press **F3** LIMIT.

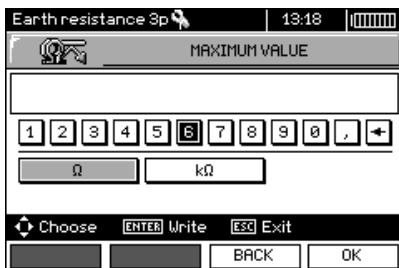

8

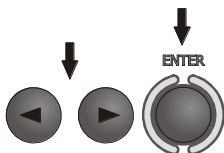

Use ◀ ▶ and **ENTER** to enter the resistance value.



9

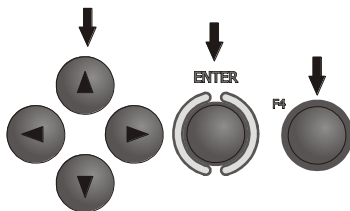

Use **←**, **→**, **▲**, **▼** and **ENTER** to select unit, confirm by pressing **F4** OK.

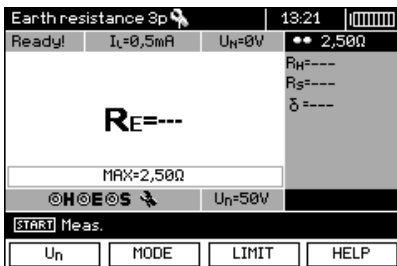

The meter is ready for measurement.
The user may read the value of interference voltage U_N and the value of the leakage current flowing through the clamps in the tested object.

Measurement

10

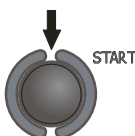

Press **START** push-button to start the measurement.

11

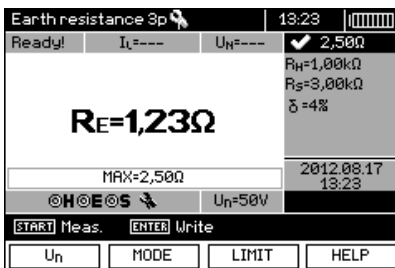

Read out the result.

- ← Resistance of current electrode
- ← Resistance of voltage electrode
- ← The value of additional uncertainty, generated by the resistance of auxiliary electrodes

The result is displayed on the screen for 20 s.
The result can be recalled by pressing **ENTER** push-button.

12

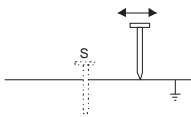

Repeat the measurements (steps 1, 10, 11) moving the voltage a few meters - placing it farther and closer to the measured earth electrode. If R_E measurement results differ from one another by more than 3 %, the distance of the current electrode from the earth electrode being tested should be considerably increased and the measurements should be repeated.



Note:



Measurement of resistance-to-earth may be carried out if voltage of interferences does not exceed 24 V. Voltage of interferences is measured up to the level of 100 V, but above 50 V it is signalled as dangerous. The meter must not be connected to voltages exceeding 100 V.

- Use C-3 clamps for the measurement. Clamps purchased with the meter must be calibrated before their first use. They may be periodically calibrated in order to prevent their ageing influence the accuracy of the measurements. Option for the calibration of clamps is included in the **MENU**.
- Maximum interference current: 1 A.
- Particular attention should be paid to quality of connection between the object being tested and the test lead – the contact area must be free from paint, rust, etc.
- If resistance of test probes is too high, R_E earth electrode measurement will be burdened with additional uncertainty. Particularly high uncertainty of measurement occurs when a small value of resistance-to-earth is measured with probes that have a weak contact with earth (such a situation occurs frequently when the earth electrode is well made and the upper soil layer is dry and slightly conductive). In such a case, the ratio of resistance of the probes to resistance of the tested earth electrode is very high and consequently, uncertainty of measurement that depends on this ratio is also very high. Then, you can make a calculations according to the formulas given in sec. 10.2 to estimate the influence of measurement conditions or you can use the graph also included in the appendix. You can improve the contact between the probe and soil, for example, by dampening with water the place where the probe is driven into earth, driving the probe into earth in a different place or using a 80 cm-long probe. Check also the test leads for possible insulation damage and for corroded or loosened connection between the banana plug and the test lead. In majority of cases the achieved measurement accuracy is satisfactory. However, you should always be aware of the uncertainty included in the measurement.
- Factory calibration does not include the resistance of the test leads. The result displayed by the meter is a sum of the resistance of the measured object and the resistance of leads.

Additional information displayed by the meter

$R_E > 1.99 \text{ k}\Omega$	Measuring range is exceeded.
$U_N > 50\text{V!}$ and continuous, modulated audio signal 	Voltage at test terminals is higher than 50 V, measurement is blocked.
 U_N	Voltage at test terminals is higher than 24 V but lower than 50 V, measurement is blocked.
NOISE!	The interfering signal (noise signal) is too high - the measurement result may be affected by additional uncertainty.
LIMIT!	The uncertainty due to the resistance of electrodes > 30 %. (For calculating uncertainty, measured values are taken into account.)
$I_L > \text{max}$	The interference current is too high, the measurement error may be larger than the basic error.

3.5.4 Measurement of resistance to earth using double clamp method

The double-clamp measurement may be applied where there is no possibility to use electrodes driven into the ground.

ATTENTION!
The double-clamp method may be only for multiple earthing measurements.

1

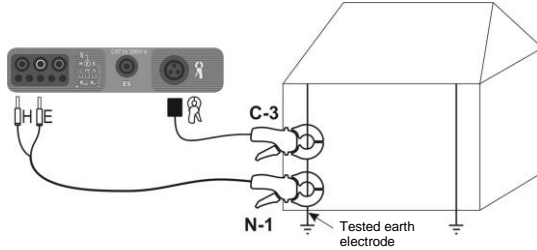

Transmitting clamps and measuring clamps should be attached to the tested earth electrode at a distance of at least 30 cm from each other. Connect transmitting clamps to **H** and **E** sockets, whereas the measuring clamps to the clamp socket.

Settings

2

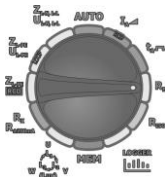

Set the rotary switch of function selection at **RE** position.

3



To select the measurement method, **F2** **MODE**.



4

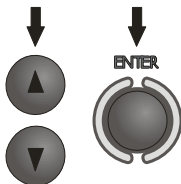

Use **▲** and **▼** to select **R1 R2**, confirm by pressing **ENTER**.

5



In order to set the limit (maximum resistance) press **F3**

LIMIT

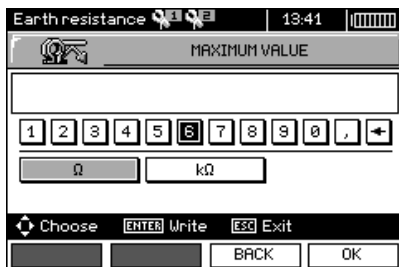

6

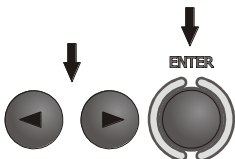

Use **◀**, **▶** and **ENTER** to enter the resistance value.

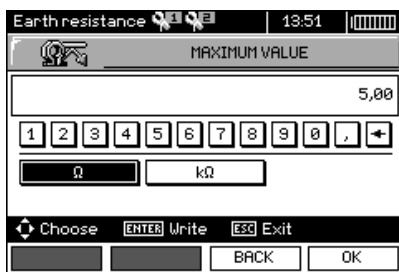

7

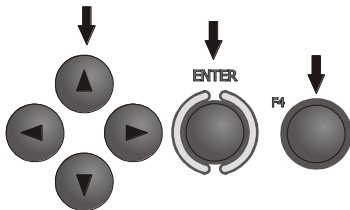

Use **◀**, **▶**, **▲**, **▼** and **ENTER** to select unit, confirm by pressing **F4**

OK



The meter is ready for measurement.

The display shows the value of the leakage current flowing through the clamps.

Measurement

8

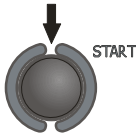

Press **START** push-button to start the measurement.

9

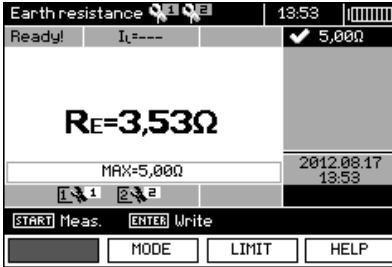

Read out the result.

The result is displayed on the screen for 20 s. The result can be recalled by pressing **ENTER** push-button.

Note:

Measurements may be performed in the presence of interference current of a value not exceeding 3 A rms and frequency in accordance with the value set in MENU.

- Use N-1 clamps as signal transmitting clamps and C-3 clamps as receiving clamps. C-3 clamps purchased with the meter must be calibrated before their first use. They may be periodically calibrated in order to prevent their ageing influence the accuracy of the measurements. Option for the calibration of clamps is included in the **MENU**.
- If the current on measuring clamps is too low, the meter displays the following message: **"Measured current is too low, measurement impossible!"**.
- Maximum interference current: 1 A.

Additional information displayed by the meter

RE>99.9Ω	Measuring range is exceeded.
UN>50V! and continuous, modulated audio signal	Voltage at test terminals is higher than 50 V, measurement is blocked.
 UN	Voltage at test terminals is higher than 24 V but lower than 50 V, measurement is blocked.
NOISE!	The interfering signal (noise signal) is too high - the measurement result may be affected by additional uncertainty.

3.5.5 Measuring soil resistivity

For soil resistivity measurements - used as preparation for the designing the earthing system or in geology measurements - a separate function is provided: measurement of soil resistivity. ρ . This function is identical to 4-pole measurement of earth resistance, however, it contains an additional procedure of entering the distance between the electrodes. The measurement result is the resistivity value, calculated automatically according to the following formula: $\rho = 2\pi LR_E$, applied in Wenner method. This method assumes equal distances between the electrodes.

1

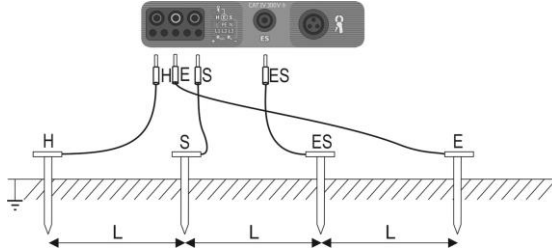

Four probes driven into the ground along one line and in equal distances must be connected as shown in the picture above.

Settings

2

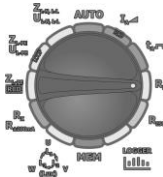

Set the rotary switch of function selection at R_E position.

3



To select the resistivity measurement, press **F2 MODE**.

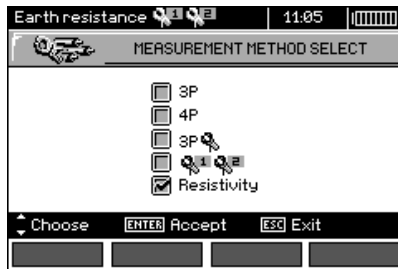

4

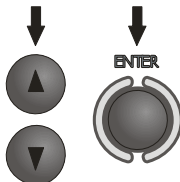

Use ▲ and ▼ to select **Resistivity**, confirm by pressing **ENTER**.

5

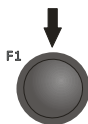

To change the measuring voltage, press **F1** **Un**.

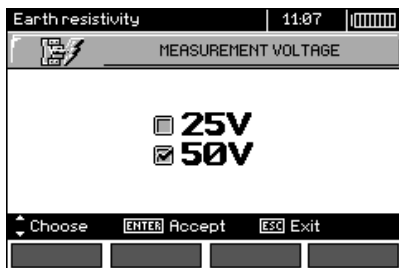

6

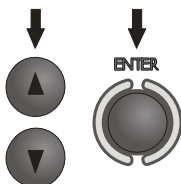

Use **▲** and **▼** select the measuring voltage, confirm by pressing **ENTER**.

7



In order to set the limit (maximum allowable resistance), press **F3** **LIMIT**.

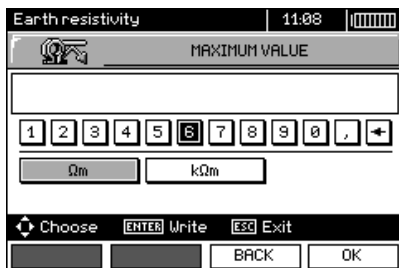

8

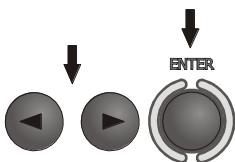

Use **◀**, **▶** and **ENTER** to enter the allowed maximum value of resistivity.

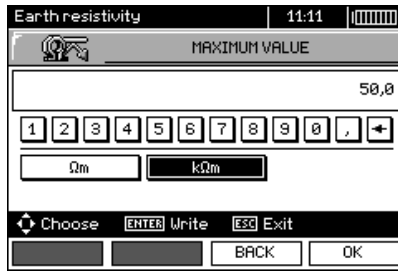

9

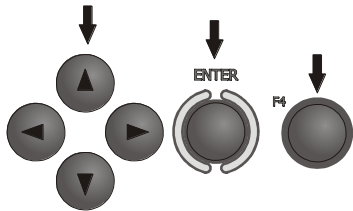

Use \leftarrow , \rightarrow , \uparrow , \downarrow and **ENTER** to select unit, confirm by pressing **F4** **OK**.

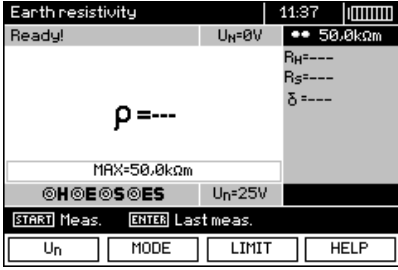

The meter is ready for measurement. Value of interference voltage U_n of the measured object may be read on the display.

Measurement

10



Press **START**, to enter into the mode of setting the distance between the probes.

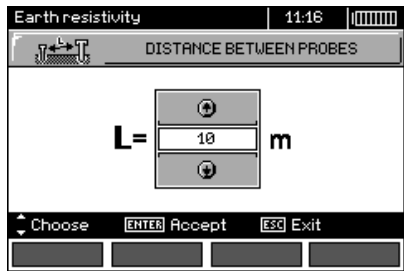

11

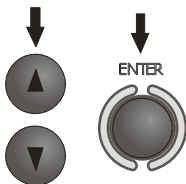

Use ▲, ▼ to select the distance between the probes, and press **ENTER** to trigger the measurement.

12

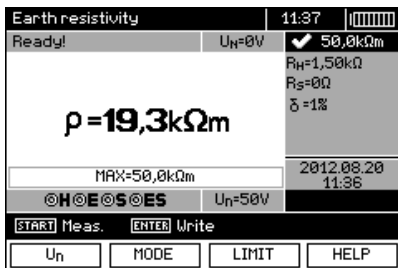

Read out the result.

- ← Resistance of current electrode
- ← Resistance of voltage electrode
- ← The value of additional uncertainty, generated by the resistance of auxiliary electrodes (probes)

The result is displayed on the screen for 20s.



The result can be recalled by pressing **ENTER** push-button.

Note:

Measurement of resistivity earth may be carried out if voltage of interferences does not exceed 24 V. Voltage of interferences is measured up to the level of 100 V, but above 50 V it is signalled as dangerous. The meter must not be connected to voltages exceeding 100 V.

- The calculations assume that the distance between the measuring electrodes are equal (Wenner method). If it is not the case, perform the measurement of earth resistance using 4-pole method and perform calculations by yourself.
- Particular attention should be paid to quality of connection between the object being tested and the test lead – the contact area must be free from paint, rust, etc.
- If resistance of test probes is too high, R_E earth electrode measurement will be burdened with additional uncertainty. Particularly high uncertainty of measurement occurs when a small value of resistance-to-earth is measured with probes that have a weak contact with earth (such a situation occurs frequently when the earth electrode is well made and the upper soil layer is dry and slightly conductive). In such a case, the ratio of resistance of the probes to resistance of the tested earth electrode is very high and consequently, uncertainty of measurement that depends on this ratio is also very high. Then, you can make a calculations according to the formulas given in sec. 10.2 to estimate the influence of measurement conditions or you can use the graph also included in the appendix. You can improve the contact between the probe and soil, for example, by dampening with water the place where the probe is driven into earth, driving the probe into earth in a different place or using a 80 cm-long probe. Check also the test leads for possible insulation damage and for corroded or loosened connection between the banana plug and the test lead. In majority of cases the achieved measurement accuracy is satisfactory. However, you should always be aware of the uncertainty included in the measurement.

Additional information displayed by the meter

RE>99.9kΩm	Measuring range is exceeded.
UN>50V! and continuous, modulated audio signal 	Voltage at test terminals is higher than 50 V, measurement is blocked.
 UN	Voltage at test terminals is higher than 24 V but lower than 50 V, measurement is blocked.
LIMIT!	The uncertainty due to the resistance of electrodes > 30 %. (For calculating uncertainty, measured values are taken into account.)
NOISE!	The interfering signal (noise signal) is too high - the measurement result may be affected by additional uncertainty.

3.6 Measurement of RCD parameters

Note:

The measurement of U_B , R_E is always performed with sinusoidal current $0,4I_{\Delta n}$, regardless of the settings concerning waveform and multiplication factor $I_{\Delta n}$.

3.6.1 Measurement of RCD disconnection current

Settings

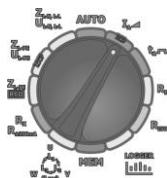

1





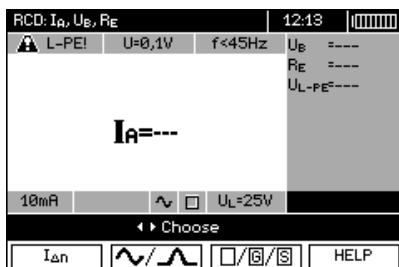

Set the rotary switch of function selection at I_A  position.

2





F1  Press **F1**  to enter $I_{\Delta n}$ selection mode.

F2  Press **F2**  to enter the selection mode for current waveform.

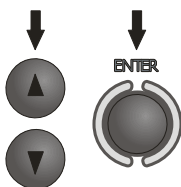
F3  Press **F3**  to enter RCD type selection mode.



Use  and  to select desired position and press **ENTER** to confirm.

3 Use ◀ and ▶ to enter the second group of parameters.

4

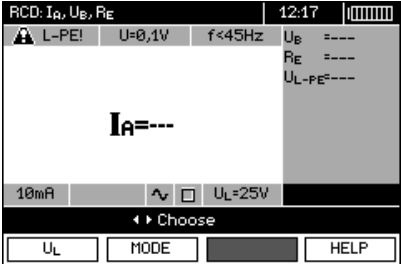

Press **F1** U_L to enter U_L selection mode.

Press **F2** **MODE** and move to selection of measurement mode.

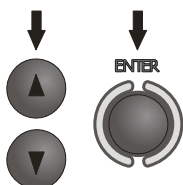

Use ▲ and ▼ to select desired position and press **ENTER** to confirm.

Measurement

5 Connect the meter to the installation according to the drawing.

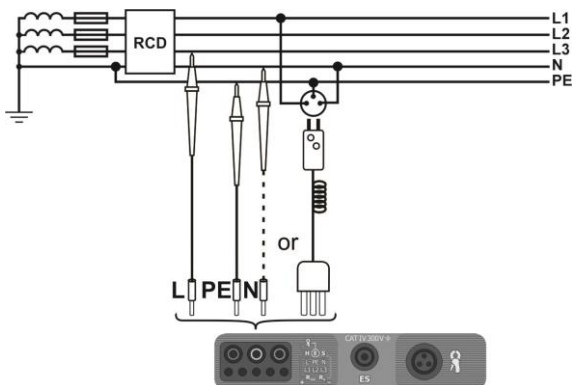

6

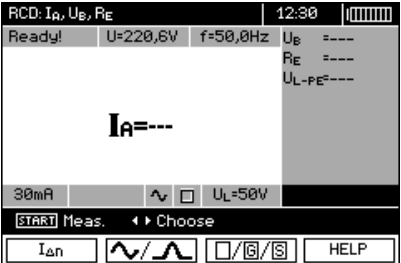

The meter is ready for measurement.
Value of network voltage and frequency can be read on the display.

7

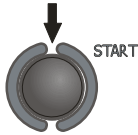

Press **START** to begin measurement.

8

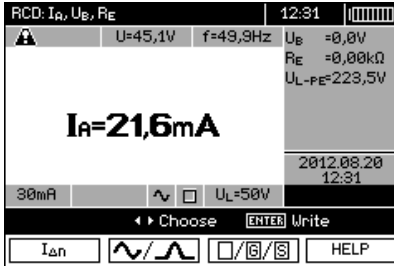

Read out the result.

Note:

- Measurement of disconnection time t_{AI} (t_A measured during I_A measurement) for selective RCD is not available.
- The measurement of response time t_{AI} is not performed as required by applicable standards (i.e with RCD nominal current $I_{\Delta n}$), but with I_A current measured and displayed during the measurement. But in most cases where the measurement does not have to be strictly as defined by the standard, this measurement may be taken into account to assess the proper operation of RCD protection in a particular installation. When measured I_A is lower than $I_{\Delta n}$ (most frequent case), then response time t_{AI} will be usually longer than the response time measured in function t_A , which measures the time at $I_{\Delta n}$ current. Therefore, when time t_{AI} is s correct (not too long), it may be assumed that the time measured in function t_A would be also correct (it would not be longer).

Additional information displayed by the meter

$U_B > U_L!$	The touch voltage exceeds a preset U_L threshold value.
!	Displayed on the right side of the result indicates a fault of RCD.
No $U_L-N!$	Lack of neutral lead that is necessary for $I_{\Delta n}$ constant and pulsed with direct current offset

The remaining information is the same as for fault loop measurement (first 7 positions in the table of section 3.4.1).

3.6.2 Measurement of RCD disconnection time

Settings

1

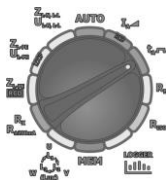

Turn the rotary switch to t_A position.

2

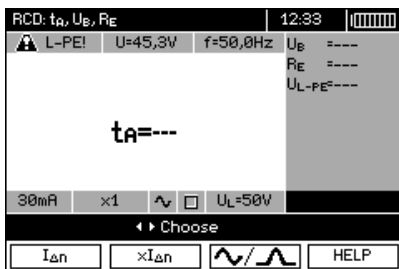

F1 Press F1 $I_{\Delta n}$ to enter $I_{\Delta n}$ selection mode.

F2 Press F2 $xI_{\Delta n}$ to enter $I_{\Delta n}$ multiplication factor selection mode.

F3 Press F3 to enter the selection mode for current waveform.

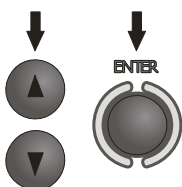

Use and to select desired position and press ENTER to confirm.

3



Use and to enter the second group of parameters.

4

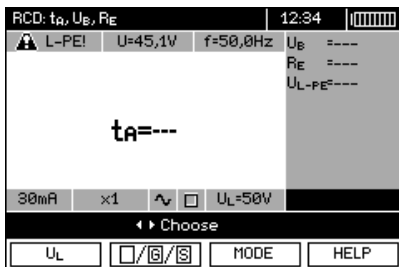

F1 Press F1 U_L to enter U_L selection mode.

F2 Press F2 to enter RCD type selection mode.

F3 Press F3 **MODE** and move to selection of measurement mode.

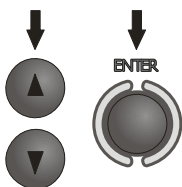

Use and to select a suitable position and press ENTER to confirm.

Measurement

5

Connect the meter to the installation according to the drawing.

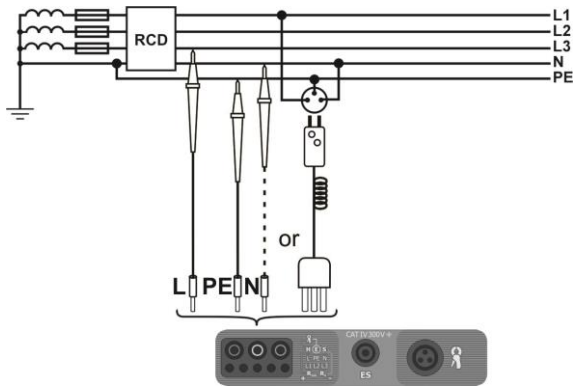

6

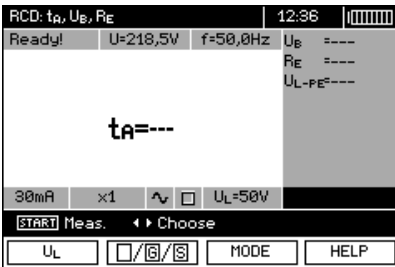

The meter is ready for measurement.
Value of network voltage and frequency can be read on the display.

7

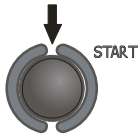

Press **START** to begin measurement.

8

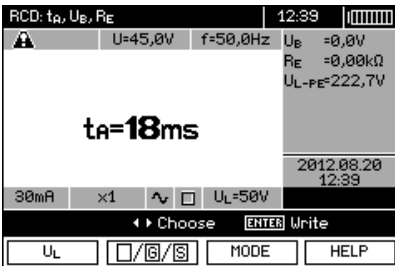

Read out the result.

Remarks and information are the same as for I_A measurement.

3.6.3 Automatic measurement of RCD parameters

The meter enables user to measure automatically RCD triggering time (t_A), disconnection current ($I_{\Delta n}$), contact voltage (U_B) and resistance-to-earth (R_E). Additionally, it is possible to automatically measure loop impedance Z_{L-PE} **RCD** in the manner described in section 3.4.3. In this mode, there is no need to trigger every single measurement by pressing **START**, and the role of the user is reduced to initiating the measurement by single pressing **START** and switching RCD on after each tripping.

- Full mode: measurement for all current waveforms of a given type of RCD (AC, A, B, B+, F).
 - Standard mode: measurement for a selected current waveform.
- Mode selection is described in Section 2.2.

3.6.3.1 Full Mode

Settings

1

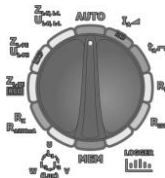

Set the rotary switch of function selection at **AUTO** position.

2

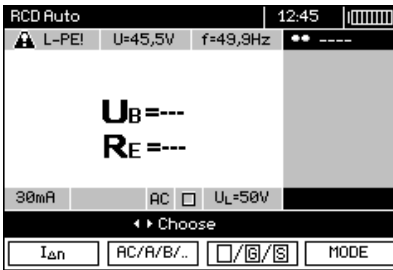

- F1 ↓ Press **F1** $I_{\Delta n}$ to enter $I_{\Delta n}$ selection mode.
- F2 ↓ Press **F2** AC/A/B/.. to enter RCD selection mode.
- F3 ↓ Press **F3** □/□/□/□ to enter RCD type selection mode.
- F4 ↓ Press **F4** **MODE** to enter the selection of measurement mode (RCD parameters for measurement).

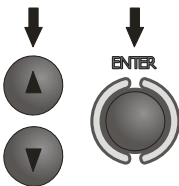

Use ▲ and ▼ to select a suitable position and press **ENTER** to confirm.

3



Use ◀ and ▶ to enter the second group of parameters.

4

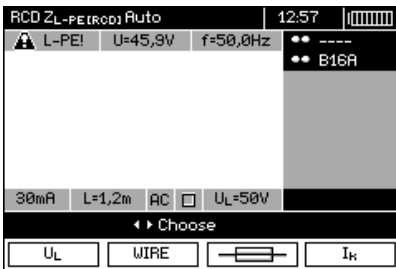

Press **F1** U_L to enter U_L selection mode.

Press **F2** $WIRE$ to enter the selection of lead length "L" (for Z_{L-PE} RCD measurement without WS network plug).

Press **F3** I_k to enter the selection of overcurrent protection (only for measurement of Z_{L-PE} RCD).

Press **F4** I_k to enter the selection of calculation method for I_k (in relation to U_n or U_0 - (only for measurement of Z_{L-PE} RCD)).

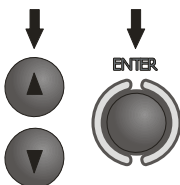

Use \blacktriangle and \blacktriangledown to select desired position and press **ENTER** to confirm. For selecting the security means, use \blacktriangleleft and \blacktriangleright to select the parameter and the use \blacktriangle and \blacktriangledown to select its value.

Measurement

5

Connect the meter to the installation according to the drawing.

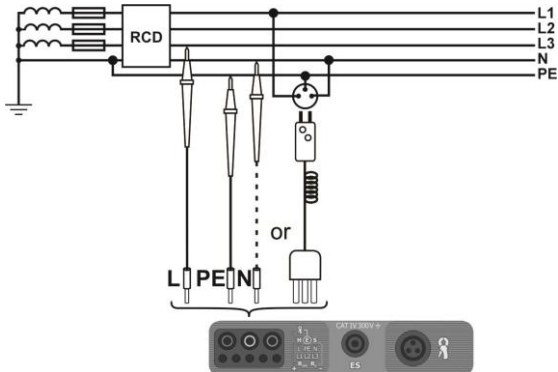

6

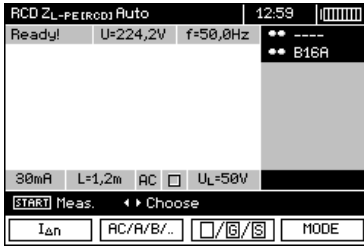

The meter is ready for measurement. Value of network voltage and frequency can be read on the display.

7

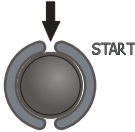

Press **START** push-button to start the measurement. If such measurements are selected that require triggering of RCD, operator of the meter should be in the vicinity of RCD and switch it on each time after it is triggered until the measurements are completed (a longer interruption may signify completion of the measurements).

8

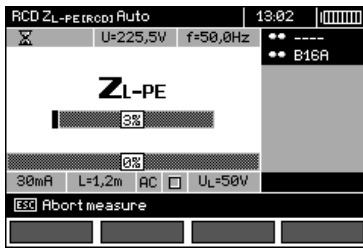

Progress of measurement process is shown by progress bars: bottom - the whole cycle, upper – Z_{L-PE} RCD measurement and RCD parameters.

9



Read out the result.

10

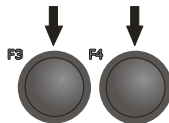

Use **F3** ◀Screen and **F4** Screen▶ to change displayed result groups.



Note:

- The number of measured parameters depends on the settings entered in the main menu.
- U_B and R_E are always measured.
- Automatic measurement is interrupted in the following cases:
 - the switch was tripped during the measurement of U_B , R_E or t_A at the half value of $I_{\Delta n}$,
 - the switch did not trip during other component measurements,
 - the value of safe voltage U_L has been exceeded,
 - voltage was disconnected during one of the component measurements,
 - values R_E and mains voltage did not allow to generate the required current value for one of component measurements.
- The meter automatically skips the measurements impossible to perform, e.g. when the value of selected $I_{\Delta n}$ current and its multiplication factor exceed the testing range of the meter.
- Criteria for assessing the correctness of component results:
 - $0.5 \cdot I_{\Delta n} \leq I_A \leq 1 \cdot I_{\Delta n}$
 - $0.35 \cdot I_{\Delta n} \leq I_A \leq 2 \cdot I_{\Delta n}$ for $I_{\Delta n} = 10 \text{ mA}$
 - $0.35 \cdot I_{\Delta n} \leq I_A \leq 1.4 \cdot I_{\Delta n}$ for remaining $I_{\Delta n}$
 - $0.5 \cdot I_{\Delta n} \leq I_A \leq 2 \cdot I_{\Delta n}$
 - t_A at $0.5 \cdot I_{\Delta n} \rightarrow \text{rcd}$, for all types of RCD
 - t_A at $1 \cdot I_{\Delta n} \leq 300 \text{ ms}$ for standard RCD's
 - t_A at $2 \cdot I_{\Delta n} \leq 150 \text{ ms}$ for standard RCD's
 - t_A at $5 \cdot I_{\Delta n} \leq 40 \text{ ms}$ for standard RCD's
 - $130 \text{ ms} \leq t_A$ at $1 \cdot I_{\Delta n} \leq 500 \text{ ms}$ for selective RCD's
 - $60 \text{ ms} \leq t_A$ at $2 \cdot I_{\Delta n} \leq 200 \text{ ms}$ for selective RCD's
 - $50 \text{ ms} \leq t_A$ at $5 \cdot I_{\Delta n} \leq 150 \text{ ms}$ for selective RCD's
 - $10 \text{ ms} \leq t_A$ at $1 \cdot I_{\Delta n} \leq 300 \text{ ms}$ for short-time delay RCD's
 - $10 \text{ ms} \leq t_A$ at $2 \cdot I_{\Delta n} \leq 150 \text{ ms}$ for short-time delay RCD's
 - $10 \text{ ms} \leq t_A$ at $5 \cdot I_{\Delta n} \leq 40 \text{ ms}$ for short-time delay RCD's
- Store the result in the memory (see sec. 4.2) or press **ESC**, and display only network voltage and frequency.
- Remaining remarks and information are the same as for I_A and Z_{L-PE} measurement.

3.6.3.2 Standard mode

Settings

1

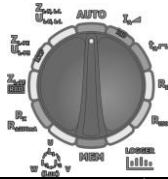

Set the rotary switch of function selection at **AUTO** position.

2

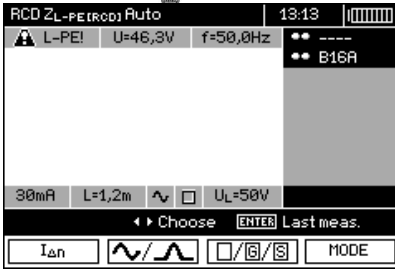

- F1 ↓ Press F1 to enter I_{Δn} selection mode.
- F2 ↓ Press F2 to enter the selection mode for current waveform.
- F3 ↓ Press F3 to enter RCD type selection mode.
- F4 ↓ Press F4 **MODE** to enter the measurement mode.

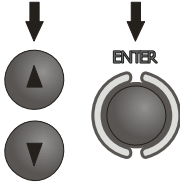

Use ▲ and ▼ to select a suitable position and press **ENTER** to confirm.

3



Use ◀ and ▶ to enter the second group of parameters.

4



- F1 ↓ Press F1 to enter U_L selection mode.
- F2 ↓ Press F2 **WIRE** to enter the selection of lead length "L" (for Z_{L-PE} RCD measurement without WS network plug).
- F3 ↓ Press F3 to enter the selection of overcurrent protection (only for measurement of Z_{L-PE} RCD).
- F4 ↓ Press F4 to enter the selection of calculation method for I_k (in relation to U_n or U₀ - (only for measurement of Z_{L-PE} RCD)).

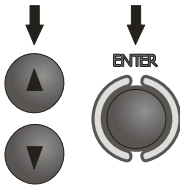

Use ▲ and ▼ to select desired position and press **ENTER** to confirm. For selecting the security means, use ◀ and ▶ to select the parameter and the use ▲ and ▼ to select its value.

Measurement

5

Connect the meter to the installation according to the drawing.

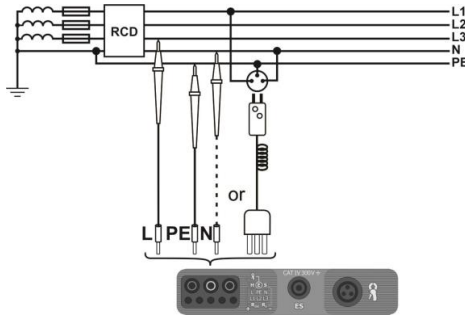

6

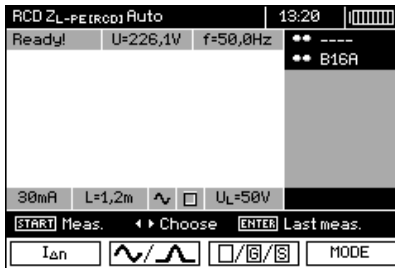

The meter is ready for measurement. Value of network voltage and frequency can be read on the display.

7

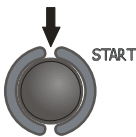

Press **START** push-button to start the measurement. If such measurements are selected that require triggering of RCD, operator of the meter should be in the vicinity of RCD and switch it on each time after it is triggered until the measurements are completed (a longer interruption may signify completion of the measurements).

8



Progress of measurement process is shown by progress bars: bottom - the whole cycle, upper - Z_{L-PE} RCD measurement and RCD parameters.

9

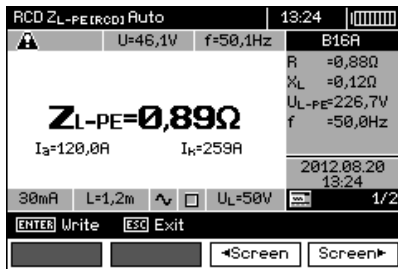

Read out the result.

10

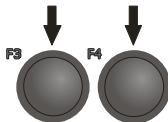

Use F3 ◀Screen and F4 Screen▶ to change displayed result groups.



Note:

- Remarks the same as in sec. 3.6.3.1.

3.6.4 MPI-530-IT Measurements in IT networks

Before making measurements, the proper network type (earthing system) shall be set in main menu of the meter, see point 2.2.1.

WARNING:
When IT network type (IT system) is chosen, touch electrode on the meter is disabled.

Connection of the meter to installation is show on the drawings below.

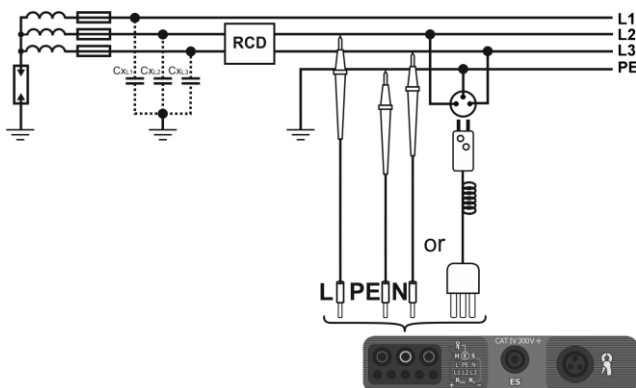

a) Parasitic capacitance is used during the measurement.

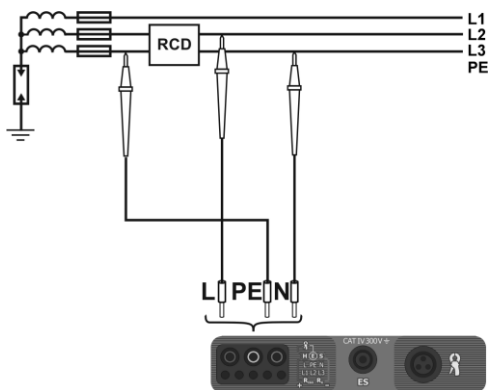

b) If there is a possibility of connecting PE channel of the meter before the RCD.

The way of making measurements of RCD tripping time and current and automatic measurements is described in points 3.6.1, 3.6.2 and 3.6.3. Operating voltage range: 95 V ... 270 V.

4



In order to set the limit (minimum resistance), press **F3**

LIMIT

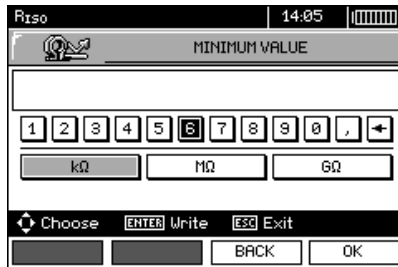

5

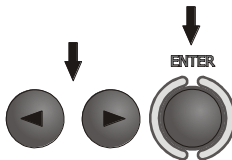

Use **◀**, **▶** and **ENTER** to enter the resistance value.

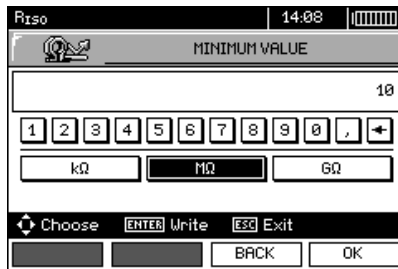

6

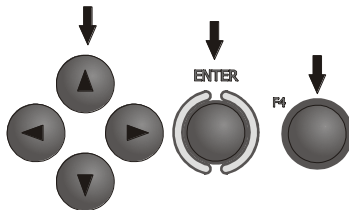

Use **◀**, **▶**, **▲**, **▼** and **ENTER** to select unit, confirm by pressing **F4**

OK

7

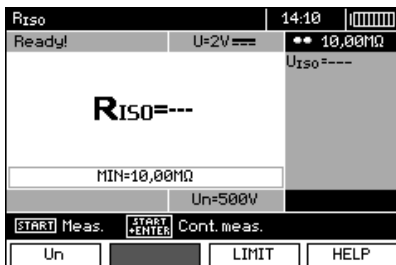

The meter is ready for measurement.

Value of interference voltage can be read on the display.

Measurement

8

Connect test leads according to the drawing.

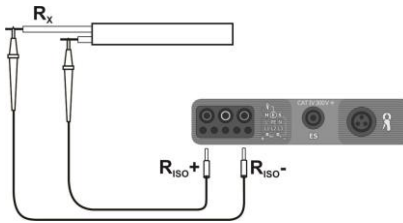

9

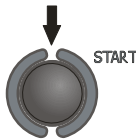

Press and hold **START** push-button. Measurement is performed continuously when the push-button is held in the pressed position.

10

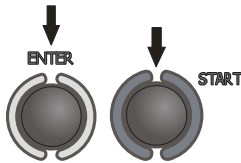

In order to maintain the measurement, press **ENTER** push-button while holding **START** push-button in the pressed position. In order to interrupt the measurement, press **START**.

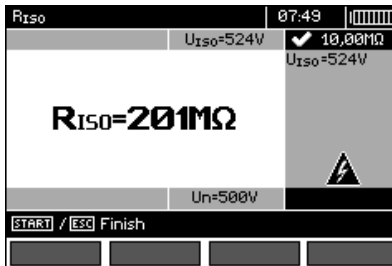

View of the screen during measurement performed with the use of **ENTER**-push-button.

11



Read out the result.

Note:



During measurements of insulation resistance, dangerous voltage up to 1 kV occurs at the ends of test leads of MPI-530 / MPI-530-IT.



It is forbidden to disconnect test leads and to change the position of the function switch before completion of measurement. Failure to obey the above instruction will lead to high voltage electric shock and make it impossible to discharge the tested object.

- The meter emits a continuous audio signal until test voltage reaches 90 % of the preset value (and also when 110 % of the preset value is exceeded).
- After completion of measurement, the capacitance of the object tested is discharged by shorting **Riso+** and **Riso-** terminals with resistance of 100 k Ω .

Additional information displayed by the meter

	Test voltage is present on terminals of the meter.
NOISE!	Interference voltage occurs on the tested object. Measurement is possible but may be burdened with additional uncertainty.
LIMIT !!	Current limit tripped. The symbol displayed during the measurement is accompanied by a continuous beep. If this symbol is displayed after the measurement, it means that the measurement result was obtained during operation with a current limiting device.

3.7.2 Measurements by means of leads with UNI-Schuko outlet plug (WS-03 and WS-04)

Settings

1

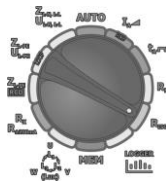

Set the rotary switch of function selection at **Riso** position.

2

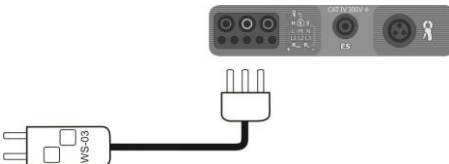

Connect WS-03 lead or WS-04 lead with UNI-Schuko outlet plug. The meter detects this fact automatically and changes the appearance of the screen.

3

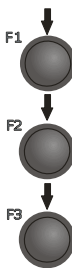
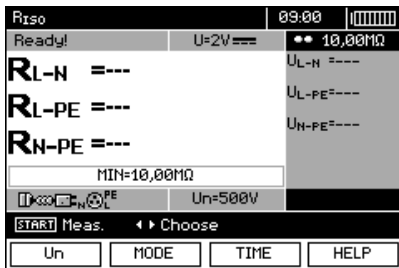

Press **F1** **U_N** push-button and move to selection of test voltage U_N.
 Press **F2** **MODE** to enter the selection of lead sequence: L, PE, N or N, PE, L or L+N, PE.
 Press **F3** **TIME** push-button and move to selection of a single measurement time.

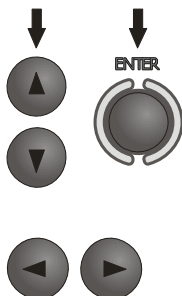

Use ▲ and ▼ to select desired position and press **ENTER** to confirm.

Note: If it is known that L and N leads in the socket are exchanged, after pressing **F2** it is possible to select the sequence of (N)(PE)(L), in order to ensure that the meter provides correct results of measurements.

Note: (L+N)(PE) mode causes the shorting of L and N wires in the tested socket.

Use ◀ and ▶ to enter the second group of parameters.

4

5

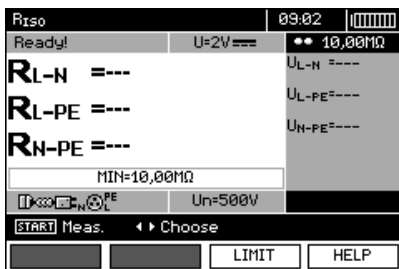

Press **F3** **LIMIT** to set the minimal resistance.

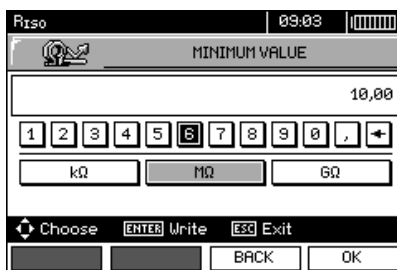

6

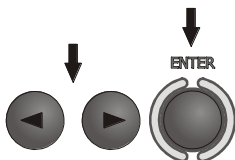

Use ◀, ▶ and ENTER to enter the resistance value.

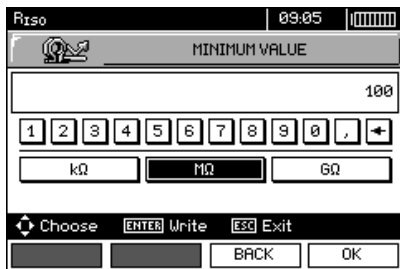

7

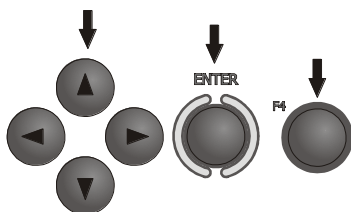

Use ◀, ▶, ▲, ▼ and ENTER to select unit, confirm by pressing F4



Measurement

8

Connect WS-03 or WS-04 lead to the socket tested.

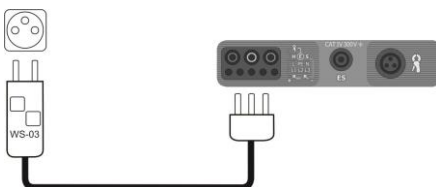



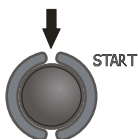

9

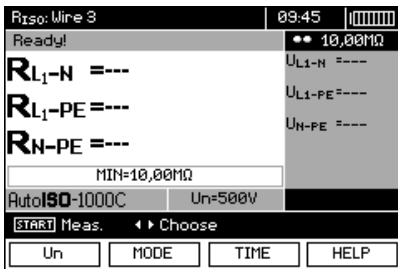

Press **START** to start measurement. If any of the voltages exceeds allowable voltage value (50 V), **Voltage on object!** message is displayed and the measurement is blocked.

3



- F1  Press **F1** **UN** push-button and move to selection of test voltage U_N .
- F2  Press **F2** **MODE** push-button and move to selection of lead type (3-, 4- or 5-wire lead).
- F3  Press **F3** **TIME** push-button and move to selection of a single measurement time.

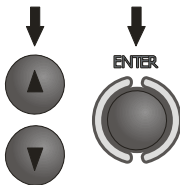

Use ▲ and ▼ to select desired position and press **ENTER** to confirm.

4



Use ◀ and ▶ to enter the second group of parameters.

5

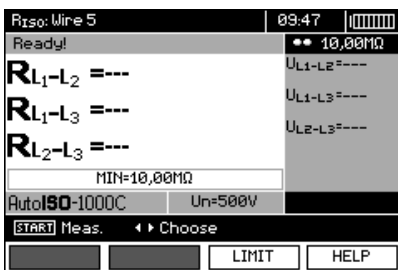

- F3  Press **F3** **LIMIT** to set the minimal resistance.

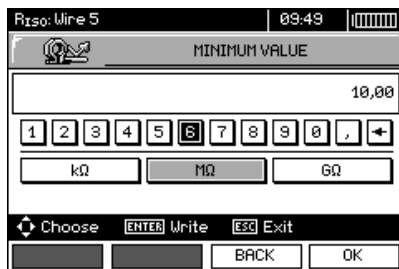

6

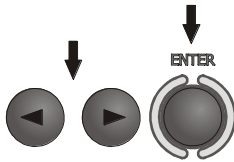

Use **◀**, **▶** and **ENTER** to enter the resistance value.



7

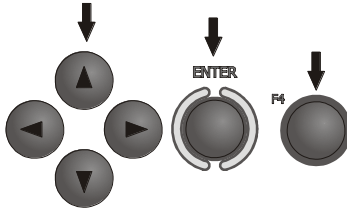

Use **◀**, **▶**, **▲**, **▼** and **ENTER** to select unit, confirm by pressing **F4** **OK**.

8

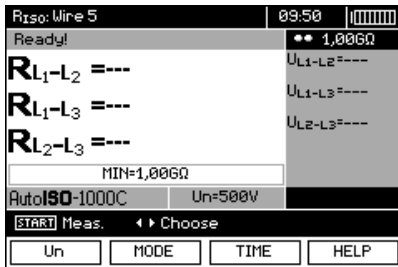

The meter is ready for measurement.
Value of interference voltage can be read on the display.

Measurement

9

Connect AutoISO-1000c adapter to the lead tested.

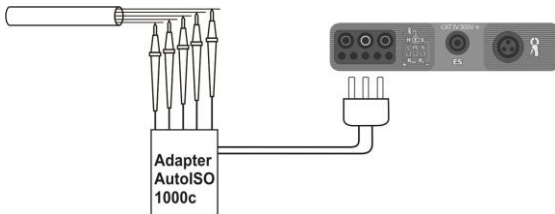

10

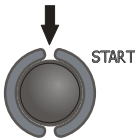

Press **START** to start measurement. First, the voltage on individual wire pairs is checked. If any of the voltages exceeds allowable values, the symbol of this voltage is displayed with "!" (e.g. U_{N-PE} !) and the measurement is interrupted.

11

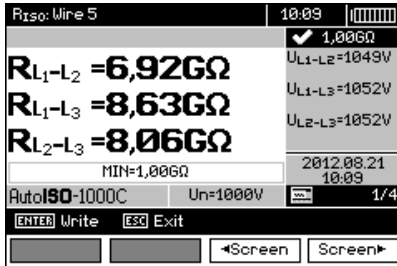

Read out the results.

12

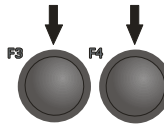

Groups of results displayed are changed by means of **F3** ◀Screen and **F4** Screen▶ push-buttons.

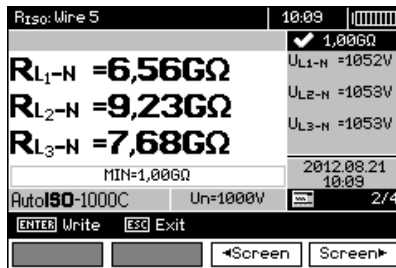

Note:

- Remarks and messages are the same as in point 3.7.1.

3.8 Low-voltage measurement of resistance

3.8.1 Measurement of resistance of protective conductors and equipotential bonding with ± 200 mA current

Settings

1

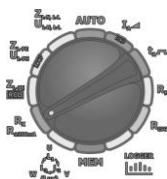

Set the rotary switch of function selection at R_x $R_{\pm 200mA}$ position.



2



Press **F1** **MODE** and move to the selection of the measurement mode.

3

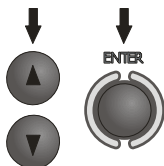

Use \blacktriangle and \blacktriangledown to select $R_{CONT} \pm 200mA$, confirm by pressing **ENTER**.

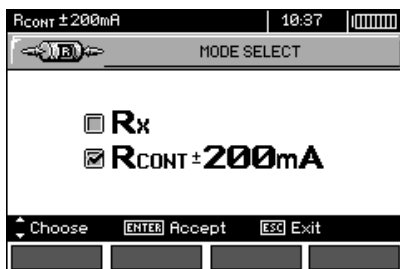

4



Press **F3** **LIMIT** to set the maximum resistance.

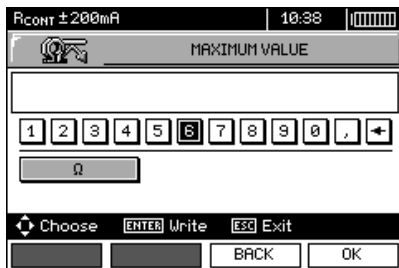

5

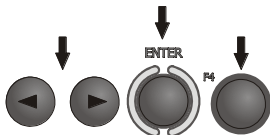

Use **◀**, **▶** and **ENTER** to enter the resistance value. Confirm by pressing **F4** **OK**.

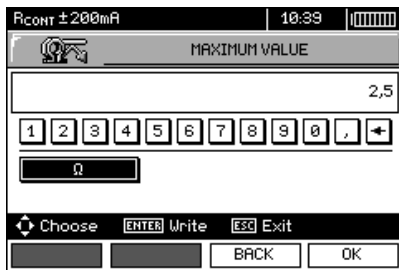

6



The meter is ready for measurement.

Measurement

7

Connect the meter to the tested object.
Measurement starts automatically.

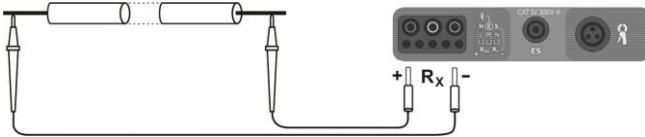

8

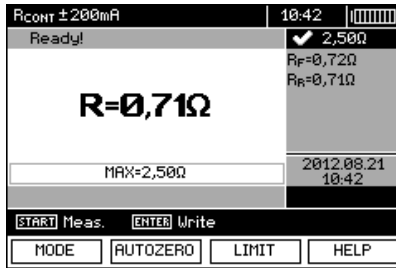

Read out the results.

9

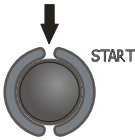

In order to start the next measurement without disconnecting test leads from the object, press **START**.

Note:

ATTENTION!

When “Voltage on object” message is displayed, the object tested is live. The measurement is blocked. The meter must be immediately disconnected from the object.

Additional information displayed by the meter

NOISE!	Interference voltage occurs on the tested object. The measurement is possible however it will be burdened with additional uncertainty that is specified in specifications.
---------------	--

Measurement

4

Connect the meter to the tested object.

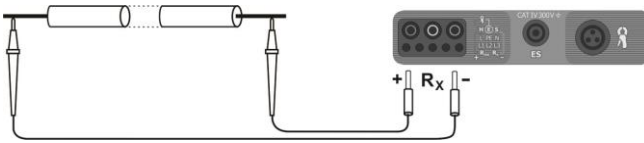

5



Read out the result.

Note:

- Remarks and messages are the same as in 3.8.1.

3.8.3 Compensation of test leads resistance

In order to eliminate the impact of the resistance of test leads on measurement result, the compensation (autozeroing) of resistance may be performed. For this purpose, R_x i $R_{\pm 200mA}$ functions have **AUTOZERO** sub-function.

1



Press **F2** **AUTOZERO**.

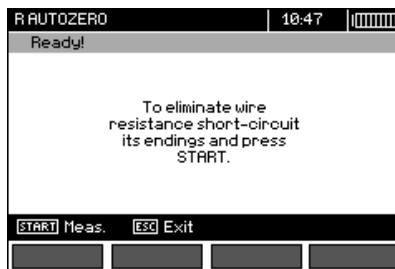

2

Follow the instructions displayed on the screen.

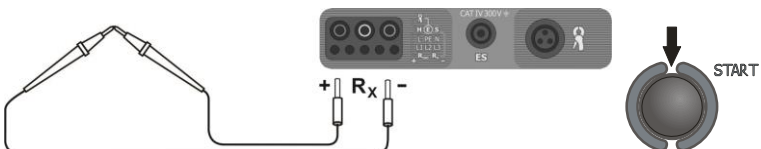

3



AUTOZERO message appears that confirms completion of test leads calibration.

4

In order to remove the compensation of the leads resistance (return to default calibration), perform the above-mentioned activities with test leads open.

3.9 Checking sequence of phases

Settings

1

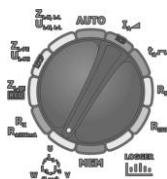

Set the rotary switch of function selection at



2



Press F1 **MODE**.

3

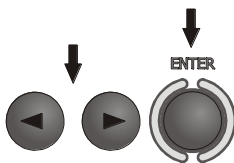

Use ◀, ▶ to select **PHASE SEQUENCE**, confirm by pressing **ENTER**.

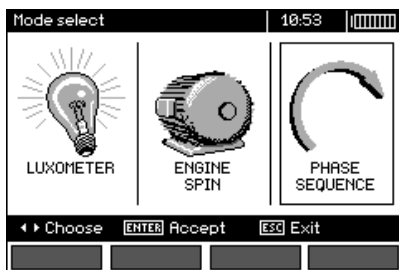

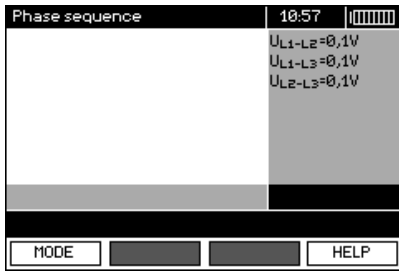

The meter ready for testing.

Measurement

4

Connect the meter to the installation according to the drawing.

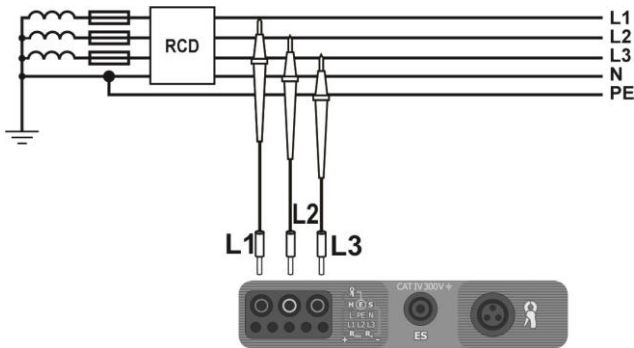

The arrow rotates clockwise:

correct sequence of phases, arrow rotates counter-clockwise: the phase sequence is incorrect.

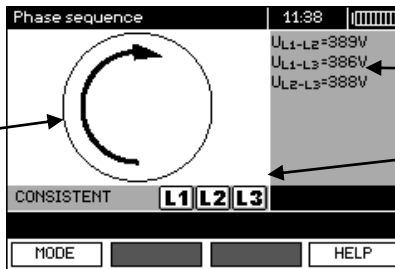

Phase-to-phase voltages.

Signalling the presence of individual phases.

3.10 Checking the motor rotation direction

Settings

①

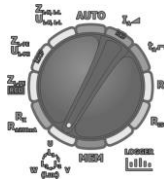

Set the rotary switch of function selection at



②



Press F1 **MODE**.

③

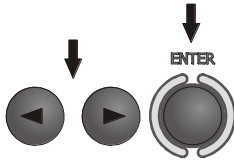

Use **◀▶** to select **MOTOR ROTATION**, confirm by pressing **ENTER**.

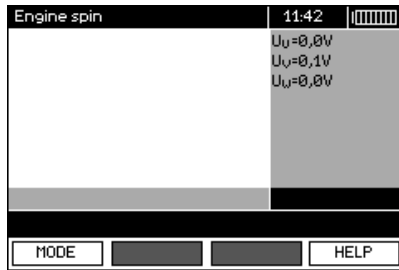
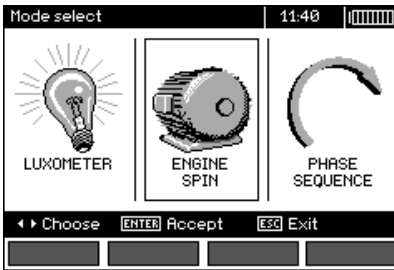

Measurement

④

Connect the meter to the motor according to the drawing.

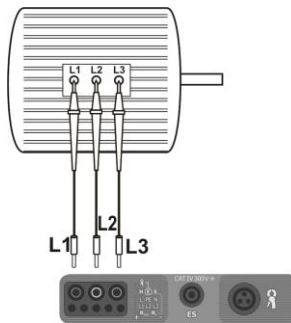

Settings

3



Connecting the probe after F1 **MODE** is pressed...

4

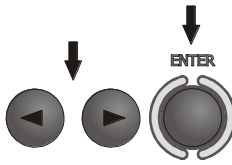

...use ◀, ▶ to select **LUXMETER**, confirm by pressing **ENTER**.

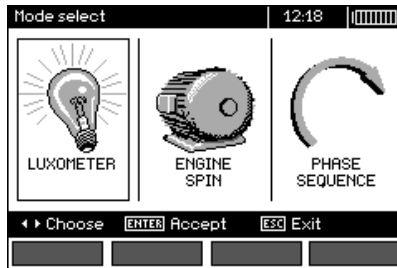

5



Press F3 **LIMIT** to set the minimum illumination.

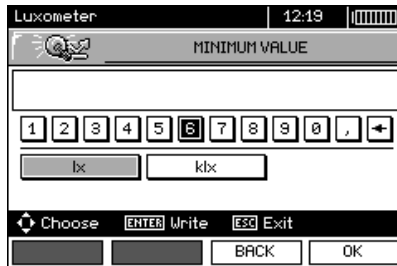

6

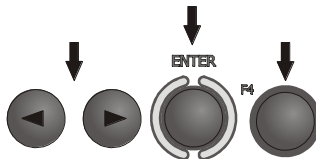

Use ◀, ▶ and **ENTER** to enter the value of lighting. Confirm by pressing **F4** **OK**.

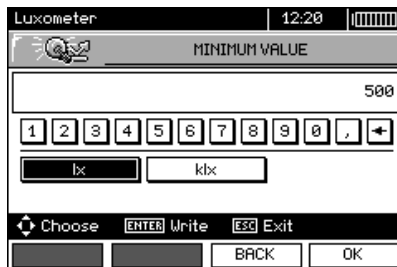

7

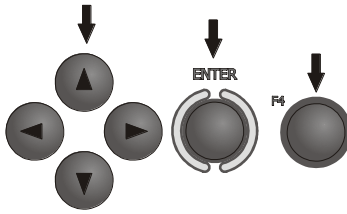

Use \leftarrow , \rightarrow , \blacktriangle , \blacktriangledown and **ENTER** to select unit. Confirm by pressing **F4**

Measurement

8

After correct location of the probe - read out the result.

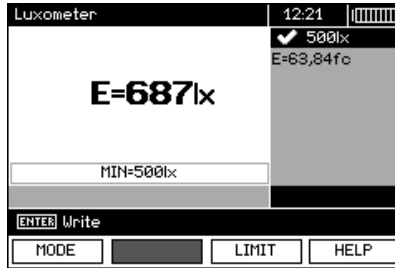

3.12 Recorder. Measurement and recording of current, voltage, $\cos\phi$, PF factor, harmonics and THD

Settings

1

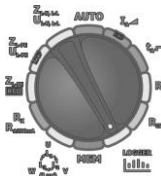

Set the rotary switch of function selection at **LOGGER** position.

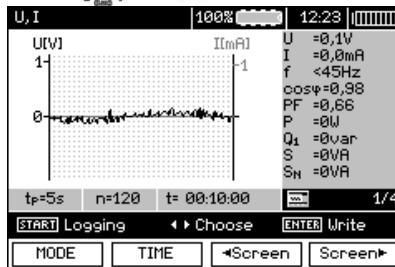

2

In MENU (section 2.2.3), select network nominal voltage and frequency. This voltage is used for calculating the deviation of measured voltage [%] from selected nominal value.

3



Press **F1** **MODE**, to select the parameters to be recorded.

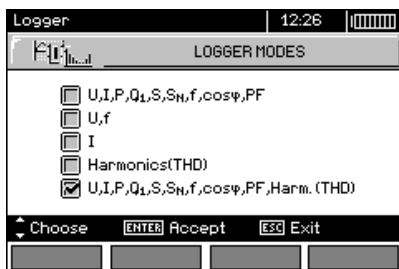

4

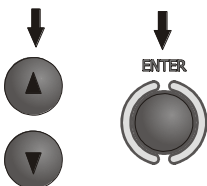

Use ▲, ▼ to select the parameter set for recording, press **ENTER** to approve.

5



Press **F2** **TIME**, to set the sampling time and number of samples.

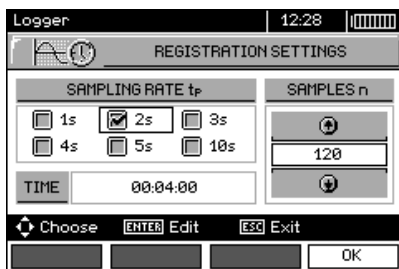

6

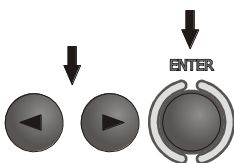

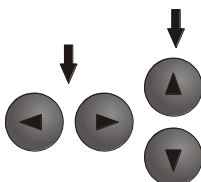

Use ◀, ▶ and **ENTER** to select the sampling period.

7



Use ◀, ▶ to select the number of samples, then use ▲, ▼ to set the number of samples - the recording time is calculated basing on the sampling time and the number of samples. Press **F4** **OK** to enter the measurement screen.

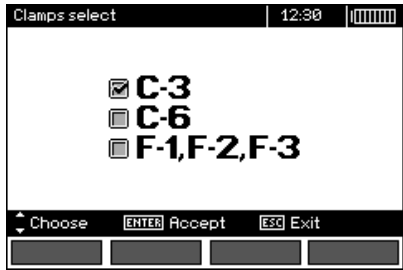
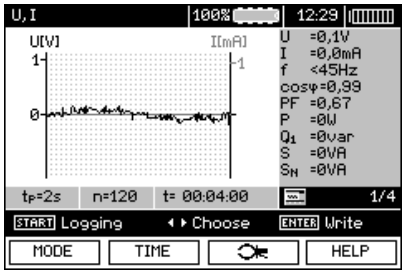

8

Use   to change the appearance of the setting bar. Press **F3**  to enter the selection of clamp type.

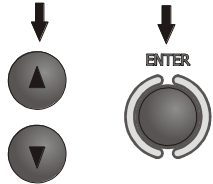

9



Use ,  to select the type of clamps, press **ENTER** to approve.

Measurement

10

Connect the device according to the drawing (example of measurement on a motor).

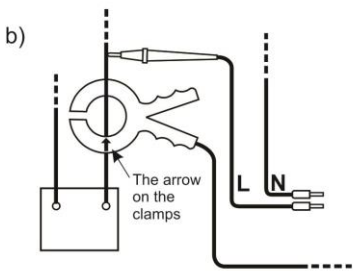
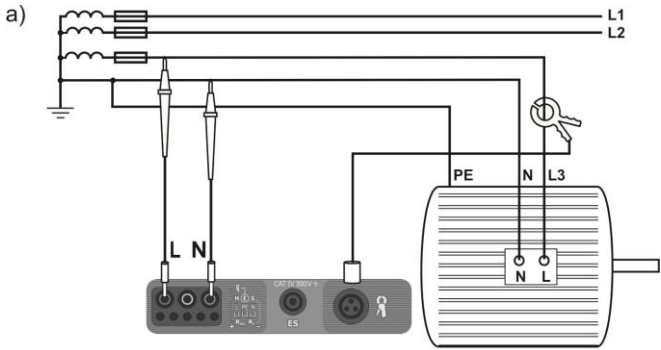

The manner of connecting clamps

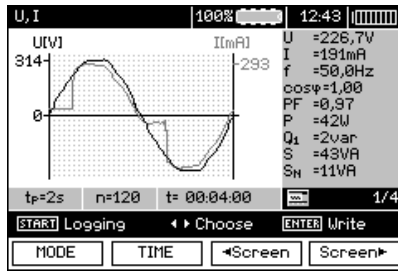

11

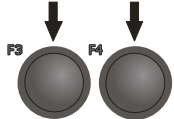

Groups of results displayed are changed by means of F3 <Screen> and F4 Screen> push-buttons.

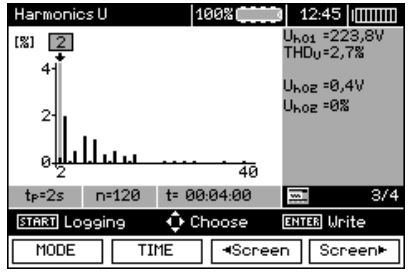
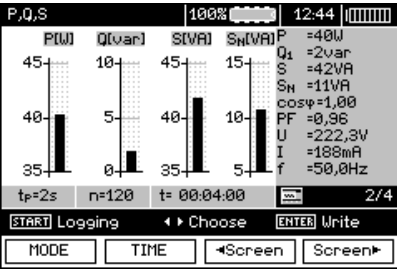

12



When displaying harmonics, use ▲, ▼ to select the number of the harmonic, with the value displayed on the right side of the screen.

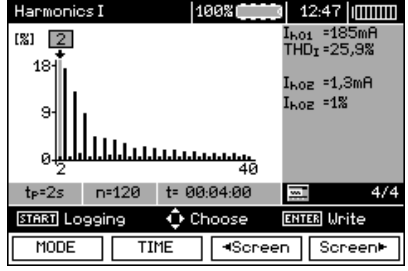
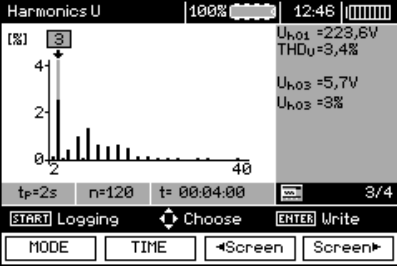

13

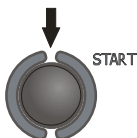

Press **START** to start recording.

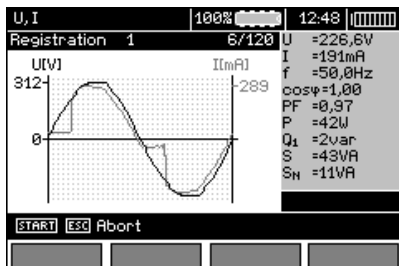

Note:

Note:

In order to avoid ambiguity in the calculating power values, attach clamps with their arrows indicating the point of connecting L terminal of the meter to the tested object (Figure b)).

- During recording only one screen is displayed - the one that was displayed at the start of recording.
- In order to save energy, the meter displays data for 30 seconds from activating it, then it enters energy saving mode (the screen is blanked, LED flashes with 1-sec intervals). Pressing any key activates the device from the standby mode.

4 Memory of measurement results

4.1 Structure of the Memory

The memory for test results has a tree-like structure (see figure below). The user has the ability to record data for ten clients. Each client may create max. 999 objects, which may store up to three levels of sub-objects, 999 sub-objects for each level. Each subject, and sub-object may store up to 999 measurements.

The whole structure is limited by the size of memory. The memory allows for simultaneous recording of 10 full descriptions of customers, and a minimum of: measurement sets for 10000 measuring points and 10000 names of these points, 999 names for objects, 999 descriptions of sub-objects and remember the layout created for these objects. Additionally the memory has a space for the list of names (selection lists) extended up to 99 entries.

4.1.1 The appearance of main windows in the measurement recording mode

The main folder window

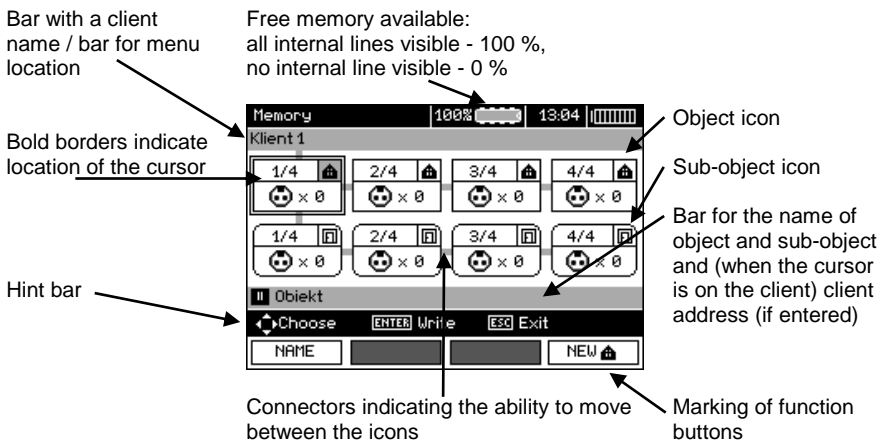

Object without any sub-object

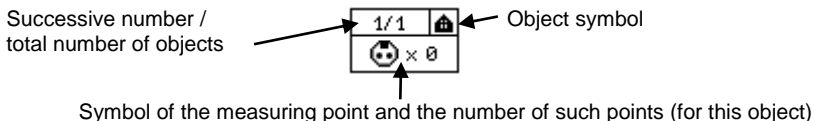

An object containing at least one sub-object

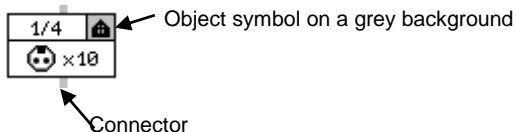

Sub-object without further sub-objects

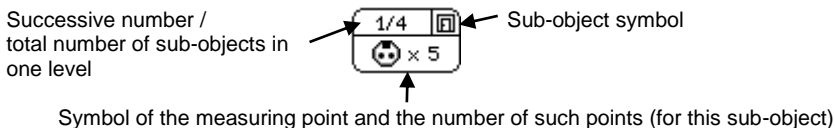

Sub-object containing more sub-objects

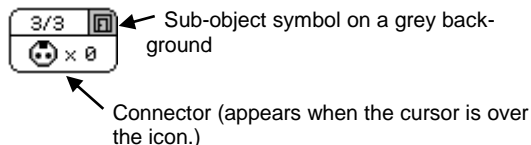

Client edit window

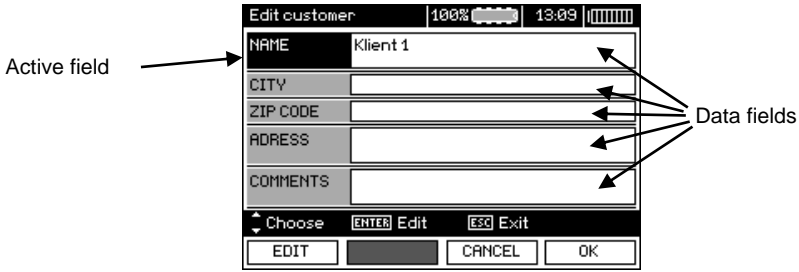

Window for entering a name

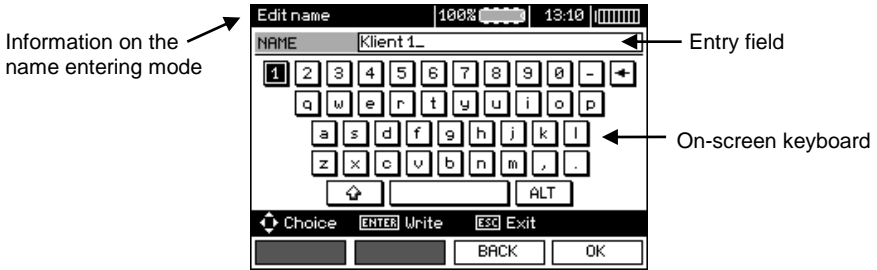

To obtain larger fonts set the cursor on **Shift** and press **ENTER**.
 To obtain special (Polish) fonts set the cursor on **ALT** and press **ENTER**.

Window for entering the measurement result

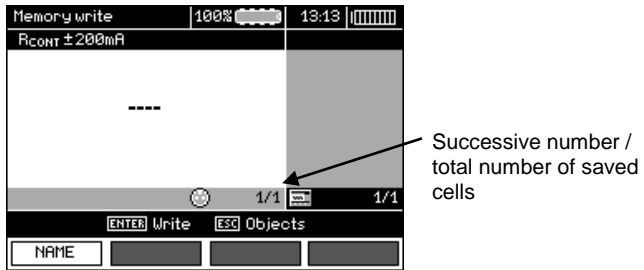

Note:

- Results of measurements performed for all measuring functions can be stored in one memory cell.
- Only the results of the measurements started by pressing **START** key button can be stored in the memory (except autozeroing in low-voltage measurement of resistance).
- Complete set of results (main result and supplementary results) for a given measuring function, pre-set measurement settings, date and time of the measurement are stored in the memory.
- Cells unsaved are not available.
- It is recommended to delete the memory after reading the data or before performing a new series of measurements that may be stored into the same memory cells as the previous ones.

4.2 Storing the measurement results data in the memory



Press **ENTER** after finishing the measurement.

4.2.1 Entering the results without extending the memory structure

1



Press **ENTER** again.



Cell free for a given type of measurement.



A cell reserved for a given type of measurement.

2

In order to select a measurement point (cell), use ▲ and ▼.

3

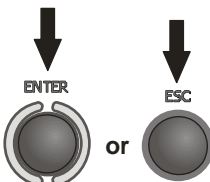

Press **ENTER**, to save the result in the memory or **ESC**, to return to displaying the memory structure.

- 4 If you try to store data in an occupied memory cell, the following warning message will appear:

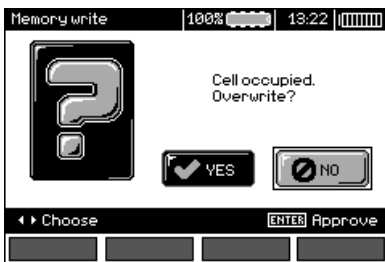

5

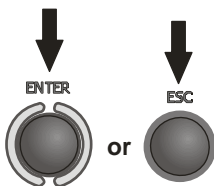

Press **ENTER**, to overwrite the result or **ESC**, to cancel saving.

Note:

- In case of RCD the above warning message will appear also when an attempt is made to store a result of specific measurement (or result component) that has been made at different preset $I_{\Delta n}$ current or for a different preset type of RCD (standard / short-time delay / selective) than the measurements the results of which are already stored in this cell, despite the fact that the memory space designated for this result component may be free. When results of measurements made for a different type of RCD or a different $I_{\Delta n}$ current are stored, the results concerning a given RCD that have been stored previously will be lost.

4.2.2 Extending the memory structure



1

Press **ESC** to start creating the objects.

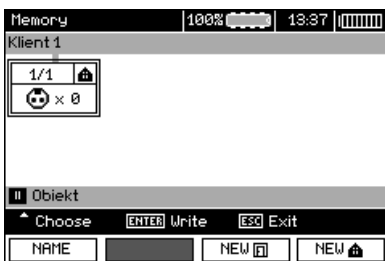

- 2 Press ▲ to set the cursor on **Client 1**.

Memory 100% 13:40

Client 1

1/1

Choose ESC Exit

EDIT

- 3 Use ◀, ▶ to move to another client (1 - 10).

- 4 Press F1 **EDIT** to edit client data.

Edit customer 100% 09:11

NAME Klient 1

CITY

ZIP CODE

ADDRESS

COMMENTS

Choose ENTER Edit ESC Exit

EDIT CANCEL OK

- 5 Use ▲ and ▼ to set the cursor on each item and press **ENTER** to start the editing.

Edit name 100% 09:15

NAME Klient 1_

1 2 3 4 5 6 7 8 9 0 - <

q w e r t y u i o p

a s d f g h j k l

z x c v b n m , .

↑ ALT

Choice ENTER Write ESC Exit

BACK OK

- 6 Use ◀, ▶ and ▲, ▼ to select a character to be typed, and press **ENTER** to enter it.
Press F3 **BACK** to delete typed letters.
Press F4 **OK** to confirm data and return to the screen of step 3.

7

In this way, you may enter all client data.

NAME	SONEL S. A.
CITY	Swidnica
ZIP CODE	58-100
ADDRESS	ul. Wokulskiego 11
COMMENTS	

Choose ENTER Edit ESC Exit

EDIT CANCEL OK

8

Press **F4** **OK** to confirm data and return to the screen of step 1.

9

Use ▼ to set the cursor on the object icon. Press **F1** **NAME** to start editing the object name.

NAME Obiekt_

1 2 3 4 5 6 7 8 9 0 - +

q w e r t y u i o p

a s d f g h j k l

z x c v b n m ALT

Choice ENTER Write ESC Exit

LIST BACK OK

10

Enter the name of the object in the same way as for the customer data. You may use the list of proposed names that is available after pressing **F1** **LIST**.

1/2 Name list

1/12 Apartment

2/12 Building

3/12 Electrical substation

4/12 Floor

5/12 Ground floor

6/12 Hall

7/12 Lobby

8/12 Office

Choose ENTER Accept ESC Exit

NEW DELETE EDIT OK

After pressing **F1** **NEW** you may add further names to the list (up to 99 items), and pressing **F2** **DELETE** deletes the items.

- 11 Press **F4** **OK** to approve the name that appears on the screen.

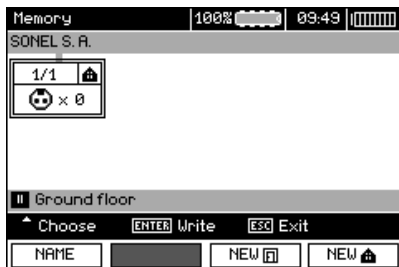

- 12 Press **ENTER**, go to the measurement point.



- 13 Press **F1** **NAME** to enter the editing of the measuring point name.

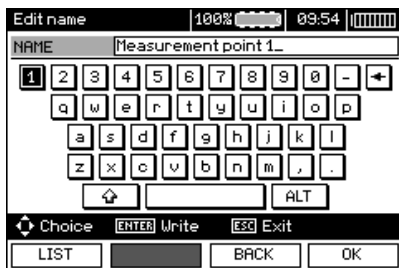

- 14 Enter the name of the measuring point in the same way as the object name.

- 15 Press **ENTER**, to save the measurement result.

After entering the memory, the user may extend its structure by adding new objects and sub-objects as needed.

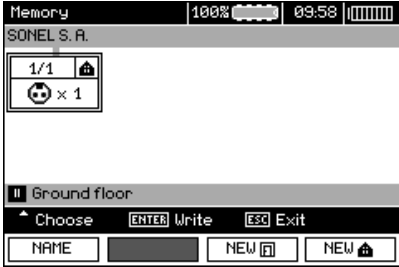

① To add a new object, press **F4** **NEW** .

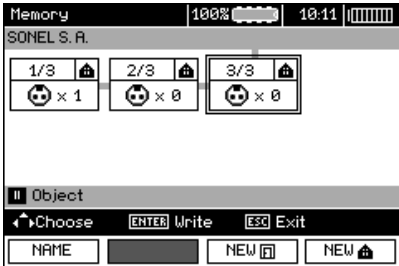

② To add a new sub-object, set the cursor on the chosen object and press **F3** **NEW** .

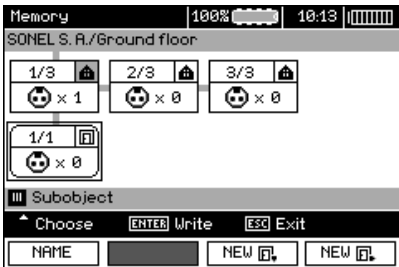

③ Using **F3** and **F4** you may add new objects and sub-objects (up to 5 levels).

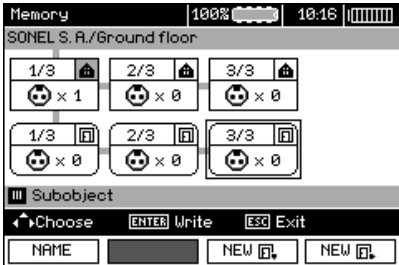

Note:

- New objects (sub-objects in a level) are added on the right side of the object marked with the cursor (sub-object).
- The screen displays only sub-objects belonging to the object (sub-object) indicated by the cursor.
- Deleting objects and sub-objects is possible only in memory browse mode.
- The name of an object, sub-object or measurement is possible in memory browse mode or after entering entry into the memory after a measurement.

4.3 Browsing and editing the memory

1

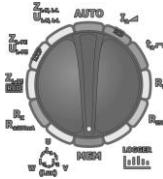

Set the rotary switch of function selection at **MEM** position.

2

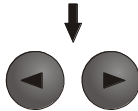

Use ◀ and ▶ to select "**MEMORY BROWSE AND EDIT**".

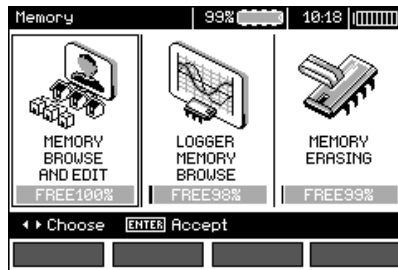

3



Press **ENTER** push-button.

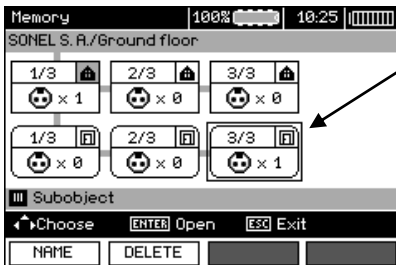

Last saved measurement in subobject 3, Level 1

4

Use ◀, ▶ and ▲, ▼ to move between objects and sub-objects using the existing connectors.

Press **F1** **NAME** to enter the option for editing the name of object (sub-object) and change it. Press **F2** **DELETE** to delete a chosen object (sub-object) with all its results.

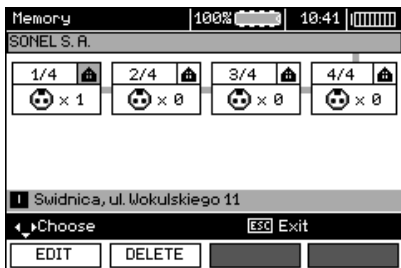

After setting the cursor on the client, use ◀, ▶ to move to next clients.

5



After selecting desired object (sub-object) press **ENTER**.

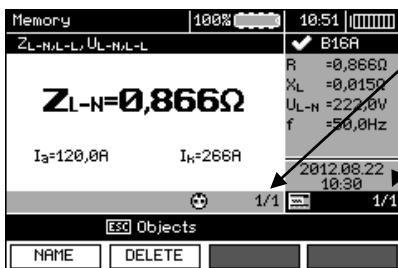

The number of measuring point / number of all measuring points.

The number of measurement type / number of all measurements types at that point.

6

Use ▲, ▼ to change the measuring point.

Press **F1** **NAME** to enter the editing of the measuring point name and to change it. Press **F2** **DELETE** to delete a chosen measuring point with all its results.

Press **F3** ◀Screen and **F4** Screen▶ to display all individual types of results for a given point.

4.4 Browsing the recorder memory

1

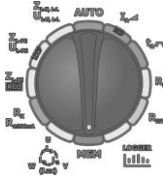

Set the rotary switch of function selection at **MEM** position.

2

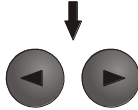

Use ◀ and ▶ to select "**LOGGER MEMORY BROWSE**".

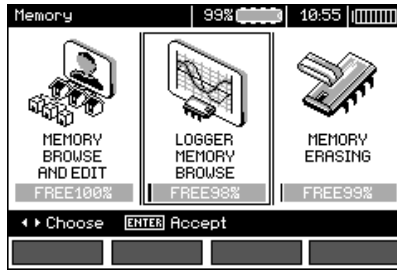

3



Press **ENTER** push-button.

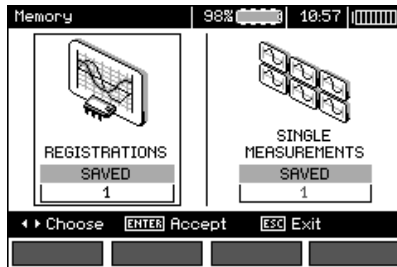

4

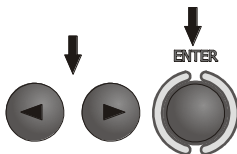

Use ◀ and ▶ to choose between browsing recorded results or single measurements. Press **ENTER** push-button.

Single measurements

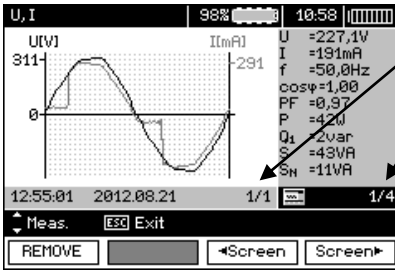

The number of a measurement / number of all measurements.

Number of the screen with results / number of all screens with results.

5

Use ▲, ▼ to display the results of subsequent measurements.

Press **F1** REMOVE to delete a chosen measurement with all its results.

Press **F3** ◀Screen and **F4** ▶Screen to display all individual results for a given measurement.

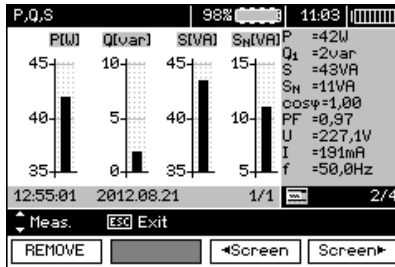

Records

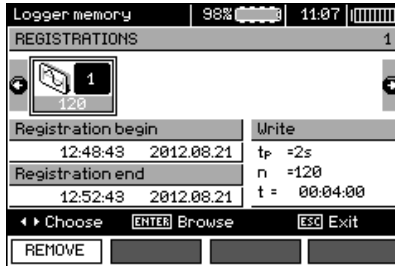

6

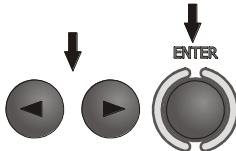

Use ◀ and ▶ to select a record to browse.
Press **ENTER** push-button.

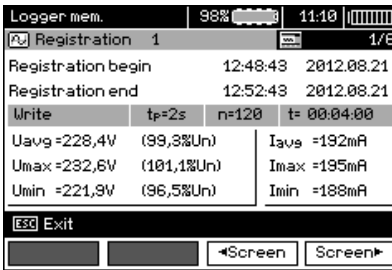

← Number of the screen with results / number of all screens with results.

← Statistical values of voltage and current.

7

Press **F3** **◀Screen** and **F4** **Screen▶** to display individual results for a given record.

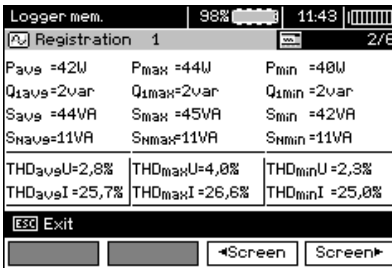

← Number of the screen with results / number of all screens with results.

← Statistical values of power and THD.

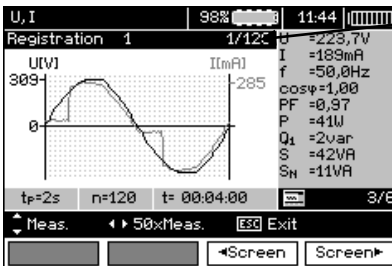

← Number of a sample / number of all samples.

← The results of measurements on successive samples.

← Number of the screen with results / number of all screens with results.

8

Press **F3** **◀Screen** and **F4** **Screen▶** to display the results of measurements in successive samples.

Now you can choose successive samples by using **▲**, **▼** and do the same during browsing through next screens.

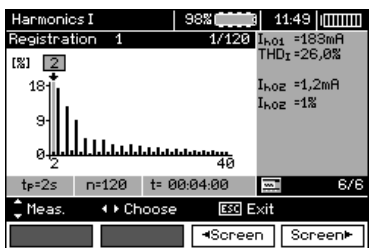
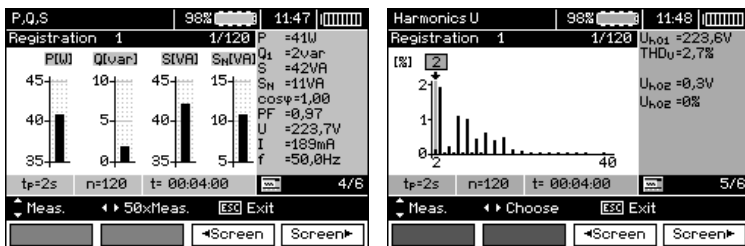

When displaying harmonics, use **◀**, **▶** to select the harmonic that you want to have expressed in numbers on the right side of the screen.

4.5 Deleting memory data

1

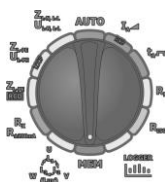

Set the rotary switch of function selection at **MEM** position.

2

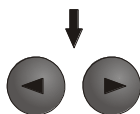

Use **◀** and **▶** to "Memory erasing".

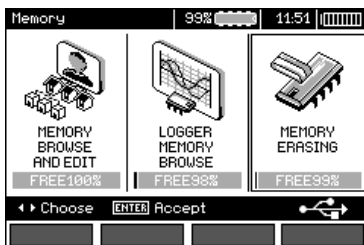

3



Press **ENTER** push-button.

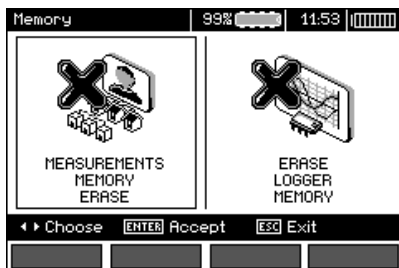

4

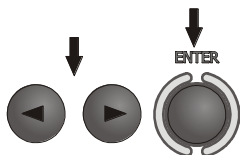

Use ◀ and ▶ to select deleting the measurements/recorder memory. Press **ENTER**-push-button.

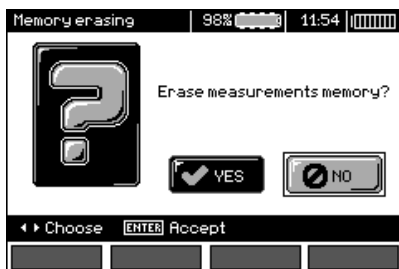

5

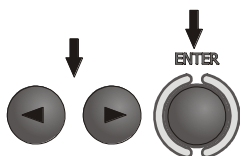

Use ◀ and ▶ to select **YES** or **NO**. Press **ENTER** push-button.

5 Data transmission

5.1 Set of accessories to connect the meter to a PC

In order to ensure the communication of the meter with a PC, a USB cable is required or Bluetooth module and appropriate software supplied with the meter.

The software may be used for many devices manufactured by SONEL S.A. which are equipped with the USB interface.

Detailed information is available from the manufacturer and distributors.

5.2 Data transmission through USB port

1. Set the rotational function selector at MEM.
2. Connect the cable to the USB port of the computer and the USB socket of the meter.
3. Start the software.

5.3 Connecting to Bluetooth mini-keyboard

5.3.1 Manual connection

In order to connect to Bluetooth keyboard (paired keyboard), go to MENU → Wireless transmission → Wireless transmission.



Turn the keyboard on and set it in pairing mode (special button on the keyboard - please refer to the manual of the keyboard). Select "F1 - Search" on the meter. The meter will search for available Bluetooth device, the operation time depends on the number of available devices within its range.



After completing the search process, the meter will display a list of available keyboards (other devices: phones, palmtops, computers, etc. are not shown).

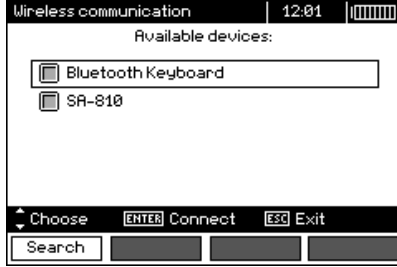

From the list of available devices, select one keyboard and press "ENTER -Connect" - the meter will display the progress bar, counting on 30 seconds. During this time use the keyboard to enter PIN code and confirm it by pressing "ENTER" key on the keyboard.

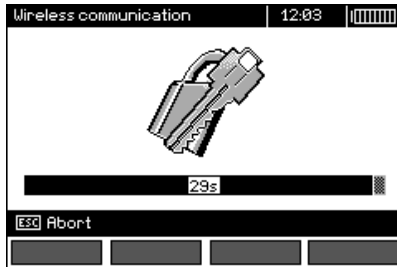

Note: The PIN code may be read or changed in MENU → Wireless transmission → Change PIN code.

The pairing operation may end in one of three following ways:

- Wireless connection enabled - pairing was successful, the keyboard has been saved in the memory and will not require re-entering the PIN, even if you change the PIN of the meter. Connection activity is indicated by  symbol, displayed near the clock and it may be seen on the list of available devices*. From this moment automatic connection is available.

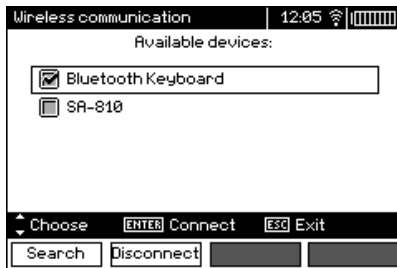

- Wireless connection error Wrong PIN number entered - connection failure, entered PIN code is not compliant with the one set in the meter.

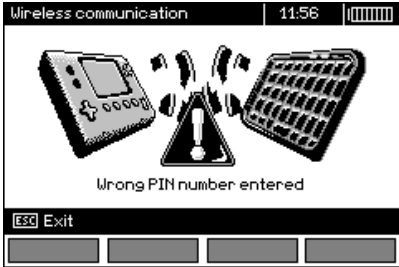

- Wireless connection error Device not found - the keyboard is no longer available for connection.

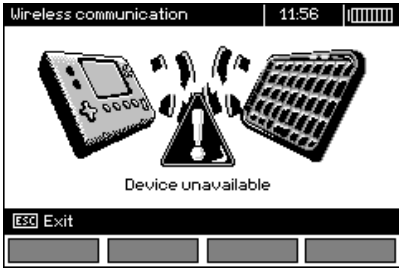

The meter may store up to 16 keyboards in its memory (each of them requires the full path of manual connection).

* The list of available devices, has also another function: the active keyboard is displayed on the list of available devices always as the first device and it is additionally marked with "V" symbol. There is an additional option available: "F2 - Disconnect". Disconnection removes the pairing with a given device, and thus automatic connection is no longer available.

5.3.2 Automatic connection

If the meter is paired with at least one keyboard, it will attempt to establish a connection to this keyboard always when the keyboard is enabled in "connect" mode. This process is automatic and always takes place, regardless of the measurement function (excluding the case of active connection to a PC via Bluetooth and charger). Automatic connection is indicated by  symbol, located near the clock. When more than one keyboard is paired with the device and at the moment, more than one keyboard is available in the connection mode, the connection will be made with the keyboard that first responds to the connection call of the meter.

5.4 Data transmission using Bluetooth module

1. Activate Bluetooth on your PC (if it is an external module, it must be connected to the computer before). Follow the instructions of the module.
2. Turn on the meter and set the function switch in **MEM** position.
3. On a PC enter Bluetooth connectivity mode, select MPI-530 / MPI-530-IT device and connect.

4. If the connection was successful, then the meter will display the following screen:

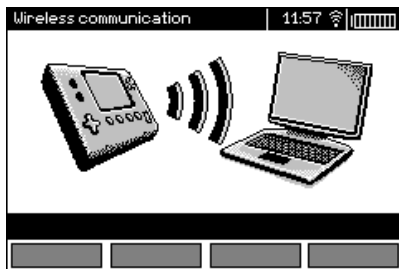

5. Start the software to read /save data (e.g., Sonel Reader, Sonel PE) and proceed in accordance with its instructions.

5.5 Read-out and change of PIN code for Bluetooth connections

Select Wireless transmission in the main MENU of the meter,



press **ENTER**.

Select **CHANGE PIN CODE** position,

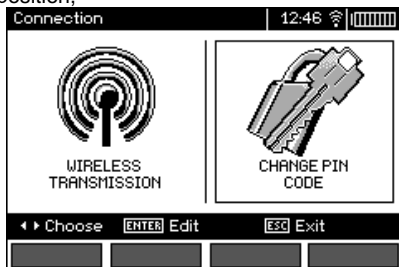

press **ENTER**.

Read the current PIN, and change it if necessary, confirming introduced change by pressing **ENTER**.

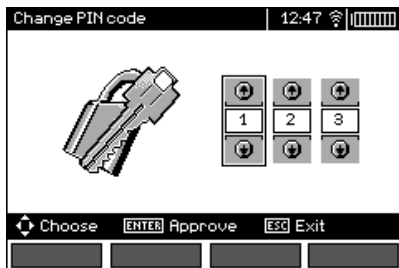

Note:



Standard PIN code for Bluetooth transmission is "123".

6 Power supply of the meter

6.1 Monitoring the power supply voltage

The level of the charge of the batteries or rechargeable batteries is currently indicated by the symbol in the right upper corner of the display:



- Batteries/ rechargeable batteries charged
- Batteries/rechargeable batteries discharged
- Batteries/rechargeable batteries fully discharged.

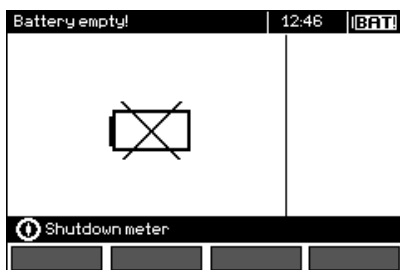

Batteries /rechargeable batteries are fully discharged, the measurement is stopped.

Note:

- Symbol **BAT!** in the display means that the supply voltage is too low and indicates that the batteries must be replaced or recharged,
- when **BAT!** is displayed, then all measurements except voltage measurements for Z and RCD functions are blocked.

6.2 Replacing batteries (rechargeable batteries)

MPI-530 meter is powered from SONEl NiMH rechargeable battery pack. It is also possible to power the meter by using four LR14 batteries.

Battery charger is installed inside the meter and cooperates only with the manufacturer's rechargeable battery pack. The charger is powered by external power supply adapter. It can be also powered from the car cigarette lighter socket. Both the rechargeable battery pack and the adapter are standard components of the meter.

WARNING:

If the test leads are left in the terminals during replacement of the batteries, there is a risk of electric shock with a dangerous voltage.

In order to replace the package of rechargeable batteries it is necessary to do the following:

- Remove all the test leads from the sockets and turn the meter off,
- Remove the four screws of the rechargeable batteries/batteries compartment (in the lower part of the casing),
- Remove the compartment,
- Remove the compartment cover and remove the batteries (rechargeable batteries),
- Insert a new package of accumulators,
- Insert (snap) the compartment cover,

- Insert the compartment in the meter,
- Screw the four screws of the rechargeable batteries/batteries compartment.

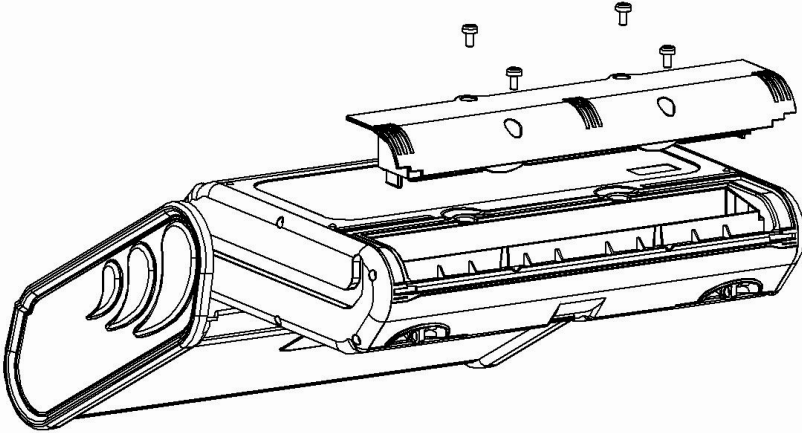

ATTENTION!

Do not use the meter when the accumulator compartment is removed or open or power it from other sources than those mentioned in this manual.

6.3 Charging rechargeable batteries

Charging commences once the power supply has been connected to the meter regardless of the fact whether the meter is on or off. During charging the screen looks as it is presented in the following illustration. The rechargeable batteries are charged in accordance with the algorithm of "quick charge" – this process reduces the charging of fully discharged batteries to approx. four hours. The end of the charging process is signalled by the following message: **End of charging**. In order to turn the device off, unplug the power charger.

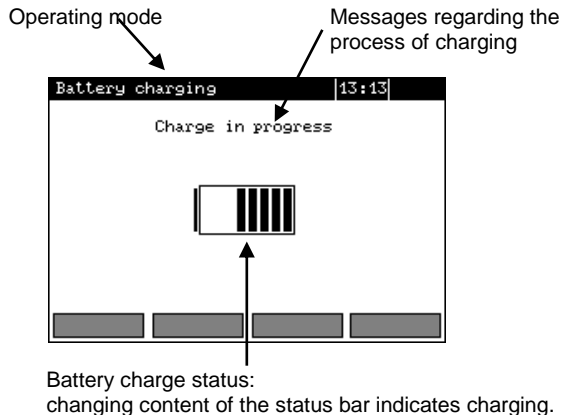

Note:

- Due to interferences in the network or to high ambient temperature, the charging process of rechargeable batteries may finish prematurely. When charging time is too short, turn off the meter and start charging again.

Additional information displayed by the meter

Message	Cause	Proceeding
Battery connection error!	Excessive voltage at the rechargeable batteries package during charging.	Check the contacts of the rechargeable batteries package. Should the problem persist, replace the package.
No battery!	No communication with the controller of rechargeable batteries or batteries compartment put in.	Check the contacts of the rechargeable batteries package. Should the problem persist, replace the package. Insert the rechargeable batteries instead of batteries.
Temperature of rechargeable batteries too low!	The ambient temperature is lower than 10°C	It is not possible to charge the rechargeable batteries correctly in such a temperature. Place the meter in a warm place and commence the charging mode anew. The present message may be displayed also in the case of deep discharging of the rechargeable batteries. It is then recommended to try to turn the charger repeatedly.
Pre-charge error	A damaged or deeply discharged rechargeable batteries package	The message is displayed for a while and then the pre-charge process begins again. If after several attempts the meter displays the following message: Battery temperature too high! the battery pack must be replaced.
Temperature of the rechargeable batteries pack is too high!	Ambient temperature is higher than 35°C	Move the meter to the environment with lower ambient temperature, and wait for its cooling.

6.4 General principles for using Ni-MH rechargeable batteries

- If you do not use the device for a prolonged period of time, then it is recommended to remove the rechargeable batteries and store them separately.

Store the rechargeable batteries in a dry, cool and well ventilated place and protect them from direct sunlight. The temperature of the environment in the case of prolonged storage should not exceed 30°C. If the rechargeable batteries are stored for a long time in a high temperature, then the occurring chemical processes may reduce their lifetime.

- Rechargeable batteries NiMH usually lasts for 500-1000 charging cycles. These batteries reach their maximum capacity after being formatted (2-3 charge/discharge cycles).

The most important factor which influences the lifetime of rechargeable batteries is the level of their discharge. The deeper the discharge level of the batteries, the shorter their lifetime.

- The memory effect is limited in the case of NiMH batteries. These batteries may be charged at any point with no serious consequences. It is however, that every few cycles, they are completely discharged.

- During storage of Ni-MH rechargeable batteries they are discharged at the rate of approximately 30% per month. Keeping rechargeable batteries at high temperatures may accelerate this process even 100%. In order to prevent excessive discharge of rechargeable batteries, after which it would be necessary to format them, it is recommended to charge them from time to time (even if they are not used).

- Modern fast chargers detect both too low and too high a temperature of rechargeable batteries and react to the situation adequately. Too low temperature should prevent starting the process of charging, which might irreparably damage rechargeable batteries. An increase of the temperature of the rechargeable batteries is a signal to stop charging and is a typical phenomenon. However charging at a high ambient temperature apart from reducing batteries' lifetime causes an accelerated increase of their temperature and the result is that the batteries are not charged to their full capacity.

- Please note that when the batteries are charged with a fast-charger they are charged only to approx. 80% of their capacity - better results can be achieved by continuing charging: the charger enters trickle-charging mode and during the next few hours batteries are charged to their full capacity.

- Do not charge or use rechargeable batteries in extreme temperatures. Extreme temperatures reduce the lifetime of batteries and rechargeable batteries. Avoid placing devices powered by rechargeable batteries in very hot environments. The nominal working temperature must be absolutely observed.

7 Cleaning and maintenance

ATTENTION!

Use only the maintenance methods specified by the manufacturer in this manual.

The casing of the meter may be cleaned with a soft, damp cloth using all-purpose detergents. Do not use any solvents or cleaning agents which might scratch the casing (powders, pastes, etc.).

Clean the probe with water and dry it. Before the probe is stored for a prolonged period of time it is recommended to grease it with any machine lubricant.

The reels and test leads should be cleaned with water and detergents, and then dried.

The electronic system of the meter does not require maintenance.

8 Storage

In the case of storage of the device, the following recommendations must be observed:

- Disconnect all the test leads from the meter.
- Clean the meter and all its accessories thoroughly.
- Wind the long test leads onto the reels.
- In the case the meter is to be stored for a prolonged period of time, the batteries must be removed from the device.
- In order to prevent a total discharge of the rechargeable batteries in the case of a prolonged storage, charge them from time to time.

9 Dismantling and utilisation

Worn-out electric and electronic equipment should be gathered selectively, i.e. it must not be placed with waste of another kind.

Worn-out electronic equipment should be sent to a collection point in accordance with the law of waste electrical and electronic equipment.

Before the equipment is sent to a collection point, do not dismantle any elements.

Observe the local regulations concerning disposal of packages and used batteries/rechargeable batteries.

10 Technical specifications

10.1 Basic data

⇒ Abbreviation "m.v." used in the specification of basic uncertainty means standard measured value

Measurement of alternating voltages (True RMS)

Range	Resolution	Basic uncertainty
0.0 V...299.9 V	0.1 V	$\pm(2 \% \text{ m.v.} + 4 \text{ digits})$
300 V...500 V	1 V	$\pm(2 \% \text{ m.v.} + 2 \text{ digits})$

- Frequency range: 45...65Hz

Measurement of frequency

Range	Resolution	Basic uncertainty
45.0 Hz...65.0 Hz	0.1 Hz	$\pm(0.1 \% \text{ m.v.} + 1 \text{ digit})$

- Voltage range: 50 ... 500V

Recorder

Measurement of current (True RMS)

Clamps C-6

Range	Resolution	Basic uncertainty*
0.0 mA ... 99.9 mA	0.1 mA	$\pm (5 \% \text{ m.v.} + 3 \text{ digits})$
100 mA...999 mA	1 mA	
1.00 A...9.99 A	0.01 A	$\pm(5 \% \text{ m.v.} + 5 \text{ digits})$

Clamps C-3

Range	Resolution	Basic uncertainty*
0.0 mA ... 99.9 mA	0.1 mA	$\pm (5 \% \text{ m.v.} + 3 \text{ digits})$
100 mA...999 mA	1 mA	
1.00 A...9.99 A	0.01 A	$\pm(5 \% \text{ m.v.} + 5 \text{ digits})$
10.0 A...99.9 A	0.1 A	
100 A...999 A	1 A	

Clamps F-1, F-2, F-3

Range	Resolution	Basic uncertainty *
1.00 A...9.99 A	0.01 A	±(0,1 % Inom + 2 digits)
10.0 A...99.9 A	0.1 A	
100 A...999 A	1 A	
1.00 kA...3.00 kA	0.01 kA	

$I_{nom} = 3000 \text{ A}$

* - Additionally take into account the uncertainty of current clamps.

Measurement of active power P, reactive power Q₁ and apparent power S and cosφ

Range [W], [VA], [var]	Resolution [W], [VA], [var]	Basic uncertainty (with regard to apparent power S) *
0...999	1	±(7 % m.v. + 3 digits)
1.00 k...9.99 k	0.01 k	±(7 % m.v. + 3 digits)
10.0 k...99.9 k	0.1 k	
100 k...999 k	1 k	
1.00 M...1.50 M	0.01 M	

- Voltage range: 0 V ... 500 V
- Current range: 0 A...1000 A (3000 A)
- Rated mains frequency f_n : 50 Hz, 60 Hz
- Number of phases of the circuit tested: 1
- Display range of cosφ: 0.00..1.00 (resolution 0.01)

*) U: 50 V...500 V, I: 10 mA...3000 A (depending on the type of clamps), error introduced by the current clamps should be taken into account

Measuring voltage harmonics

Range	Resolution	No. of harmonic	Basic uncertainty
0.0 V...500 V	0,1 (1*) V	1,2,...15	±(5 % m.v. + 3 digits)
		16,...40	±(5 % m.v. + 10 digits)

* from 300 V to 500 V

- Additionally h02...h40 values are displayed as a percent of h01 (up to 999 %).
- No measurement for DC component.

Measuring current harmonics

Range	Resolution	No. of harmonic	Basic uncertainty **
0.0 A...1000 A*	It results follows from the ranges of measurement I	1,2,...15	±(5 % m.v. + 3 digits)
		16,...40	±(5 % m.v. + 10 digits)

* - For clamps C-3, for C-6 -10 A, for clamps of F series, up to 3000 A.

** - Additionally take into account the uncertainty of current clamps.

- Additionally h02...h40 values are displayed as a percent of h01 (up to 999 %).
- No measurement for DC component.

THD (in relation to the first harmonic)

		Resolution	Basic uncertainty
Voltage THD-F (h = 2...40)	0.0 ... 999.9 % for $U_{RMS} \geq 1 \% U_{nom}$	0.1 %	±5 %
current THD-F (h = 2...40)	0.0 ... 999.9 % for $I_{RMS} \geq 1 \% I_{nom}$	0.1 %	±5 % *

* - Additionally take into account the uncertainty of current clamps.

Measurement of fault loop impedance Z_{L-PE} , Z_{L-N} , Z_{L-L}

Measurement of fault loop impedance Z_S

Test range according to IEC 61557-3:

Test lead	Test range Z_S
1.2 m	0.130 Ω ...1999.9 Ω
5 m	0.170 Ω ...1999.9 Ω
10 m	0.210 Ω ...1999.9 Ω
20 m	0.290 Ω ...1999.9 Ω
WS-03, WS-04	0.190 Ω ...1999.9 Ω

Display range:

Display range	Resolution	Basic uncertainty
0.000 Ω ...19.999 Ω	0.001 Ω	$\pm(5\% \text{ m.v.} + 0,03 \Omega)$
20.00 Ω ...199.99 Ω	0.01 Ω	$\pm(5\% \text{ m.v.} + 0,3 \Omega)$
200.0 Ω ...1999,9 Ω	0.1 Ω	$\pm(5\% \text{ m.v.} + 3 \Omega)$

- Rated operating voltage U_{nL-N} / U_{nL-L} : 110/190 V, 115/200 V, 127/220 V, 220/380 V, 230/400 V, 240/415 V
- Operating voltage range: 95 V...270 V (for Z_{L-PE} and Z_{L-N}) and 95 V...440 V (for Z_{L-L})
- Rated mains frequency f_n : 50 Hz, 60 Hz
- Operating frequency range: 45 Hz...65 Hz
- Maximum test current (for 415 V): 41.5 A (10 ms)
- Control of correctness of PE terminal connection by means of a touch electrode

Indications of fault loop resistance R_S and fault loop reactance X_S

Display range	Resolution	Basic uncertainty
0 Ω ...19.999 Ω	0.001 Ω	$\pm(5\% + 0.05 \Omega)$ of Z_S value

- Calculated and displayed for $Z_S < 20 \Omega$

Indications of short-circuit current I_k

Test range according to IEC 61557-3 can be calculated on the basis of test ranges for Z_S and nominal voltages.

Display range	Resolution	Basic uncertainty
0.055 A ...1.999 A	0.001 A	Calculated on the basis of uncertainty for fault loop
2.00 A...19.99 A	0.01 A	
20.0 A...199.9 A	0.1 A	
200 A...1999 A	1 A	
2.00 kA...19.99 kA	0.01 kA	
20.0 kA ...40.0 kA	0.1 kA	

- Prospective fault current calculated and displayed by the meter may slightly differ from the value calculated by the user with a calculator, basing on the displayed value of the impedance, because the meter calculates the current from unrounded value of fault loop impedance (which is used for displaying). As the correct value, consider I_k current value, displayed by the meter or by firmware.

Measurement of fault loop impedance Z_{L-PE} RCD (without triggering of RCD)

Measurement of fault loop impedance Z_s

Test range according to IEC 61557-3: 0.50 Ω ...1999 Ω for 1.2m leads, WS-03 and WS-04 oraz 0.51 Ω ...1999 Ω for 5m, 10m and 20m leads

Display range	Resolution	Basic uncertainty
0 Ω ...19.99 Ω	0.01 Ω	$\pm(6\% \text{ m.v.} + 10 \text{ digits})$
20.0 Ω ...199.9 Ω	0.1 Ω	$\pm(6\% \text{ m.v.} + 5 \text{ digits})$
200 Ω ...1999 Ω	1 Ω	

- It will not trip RCD's of $I_{\Delta n} \geq 30 \text{ mA}$
- Rated operating voltage U_n : 110 V, 115 V, 127 V, 220 V, 230 V, 240 V
- Operating voltage range: 95 V...270 V
- Rated mains frequency f_n : 50 Hz, 60 Hz
- Operating frequency range: 45 Hz...65 Hz
- Control of correctness of PE terminal connection by means of a touch electrode

Indications of fault loop resistance R_s and fault loop reactance X_s

Display range	Resolution	Basic uncertainty
0 Ω ...19.99 Ω	0.01 Ω	$\pm(6\% + 10 \text{ digits})$ of Z_s value

- Calculated and displayed for $Z_s < 20 \Omega$

Indications of short-circuit current I_k

Test range according to IEC 61557-3 can be calculated on the basis of test ranges for Z_s and nominal voltages.

Display range	Resolution	Basic uncertainty
0.055 A ...1.999 A	0.001 A	Calculated on the basis of uncertainty for fault loop
2.00 A...19.99 A	0.01 A	
20.0 A...199.9 A	0.1 A	
200 A...1999 A	1 A	
2.00 kA...19.99 kA	0.0 1kA	
20.0 kA ...40.0 kA	0.1 kA	

- Prospective fault current calculated and displayed by the meter may slightly differ from the value calculated by the user with a calculator, basing on the displayed value of the impedance, because the meter calculates the current from unrounded value of fault loop impedance (which is used for displaying). As the correct value, consider I_k current value, displayed by the meter or by firmware.

Measurement of parameters of RCD

- Measurement of RCD types: AC, A, B, B+, F
- Rated operating voltage U_n : 110 V, 115 V, 127 V, 220 V, 230 V, 240 V
- Operating voltage range: 95 V...270 V
- Rated mains frequency f_n : 50 Hz, 60 Hz
- Operating frequency range: 45 Hz...65 Hz

RCD trigger and response time test t_A (for measurement function t_A)

Test range according to IEC 61557-6: 0ms ... to the upper limit of displayed value

Type of RCD	Setting of multiple values	Test range	Resolution	Basic uncertainty
General and short-time delay type	0.5 $I_{\Delta n}$	0 ms..300 ms (TN/TT)	1 ms	$\pm(2\% \text{ m.v.} + 2 \text{ digits})^1$
	1 $I_{\Delta n}$	0 ms..400 ms (IT) MPI-530-IT		
	2 $I_{\Delta n}$	0 ms..150 ms		
	5 $I_{\Delta n}$	0 ms..40 ms		
Selective	0.5 $I_{\Delta n}$	0 ms..500 ms		
	1 $I_{\Delta n}$			
	2 $I_{\Delta n}$	0 ms..200 ms		
	5 $I_{\Delta n}$	0 ms..150 ms		

¹⁾ for $I_{\Delta n} = 10 \text{ mA}$ and $0.5 I_{\Delta n}$ uncertainty is $\pm(2\% \text{ m.v.} + 3 \text{ digits})$

- Accuracy of differential current setting:

for $1 \cdot I_{\Delta n}$, $2 \cdot I_{\Delta n}$ and $5 \cdot I_{\Delta n}$ 0..8 %

for $0.5 \cdot I_{\Delta n}$ -8..0 %

Effective value of forced leakage current at measurement of RCD [mA] disconnection time

$I_{\Delta n}$	Multiplication factor setting							
	0.5				1			
10	5	3.5	3.5	5	10	20	20	20
30	15	10.5	10.5	15	30	42	42	60
100	50	35	35	50	100	140	140	200
300	150	105	105	150	300	420	420	600
500	250	175	175	—	500	700	700	1000*
1000	500	—	—	—	1000	—	—	—

$I_{\Delta n}$	Multiplication factor setting							
	2				5			
10	20	40	40	40	50	100	100	100
30	60	84	84	120	150	210	210	300
100	200	280	280	400	500	700	700	1000*
300	600	840	840	—	—	—	—	—
500	1000	—	—	—	—	—	—	—
1000	—	—	—	—	—	—	—	—

* does not apply to $U_n = 110 \text{ V}, 115 \text{ V}, 127 \text{ V}$

MPI-530-IT does not apply to IT network

Measurement of resistance-to-earth R_E (for TT)

Selected nominal current of RCD	Test range	Resolution	Test current	Basic uncertainty
10 mA	0.01 k Ω ...5.00 k Ω	0.01 k Ω	4 mA	0..+10 % m.v. ± 8 digits
30 mA	0.01 k Ω ...1.66 k Ω		12 mA	0..+10 % m.v. ± 5 digits
100 mA	1 Ω ..500 Ω	1 Ω	40 mA	0..+5 % m.v. ± 5 digits
300 mA	1 Ω ..166 Ω		120 mA	
500 mA	1 Ω ..100 Ω		200 mA	
1000 mA	1 Ω ..50 Ω		400 mA	

Measurement of touch voltage U_B in relation to nominal differential current

Test range according to IEC 61557-6: 10.0 V...99.9 V

Test range	Resolution	Test current	Basic uncertainty
0 V..9.9 V	0.1 V	$0.4 \times I_{\Delta n}$	0 %..10 % of m.v. ± 5 digits
10.0 V..99.9 V			0 %..15 % of m.v.

Measurement of RCD disconnection current I_A for sinusoidal differential current

Test range according to IEC 61557-6: $(0.3...1.0)I_{\Delta n}$

Selected nominal current of RCD	Test range	Resolution	Test current	Basic uncertainty
10 mA	3.0 mA..10.0 mA	0.1 mA	$0.3 \times I_{\Delta n}..1.0 \times I_{\Delta n}$	$\pm 5 \% I_{\Delta n}$
30 mA	9.0 mA..30.0 mA			
100 mA	30 mA..100 mA	1 mA		
300 mA	90 mA..300 mA			
500 mA	150 mA..500 mA			
1000 mA	300 mA..1000 mA			

- it is possible to start the measurement from the positive of the negative half of forced leakage current
- test current duration max. 8,8 s

Measurement of RCD disconnection current I_A for differential unidirectional pulsed current and unidirectional pulsed current with 6mA direct current offset

Test range according to IEC 61557-6: $(0.35...1,4)I_{\Delta n}$ for $I_{\Delta n} \geq 30$ mA and $(0.35...2)I_{\Delta n}$ for $I_{\Delta n} = 10$ mA

Selected nominal current of RCD	Test range	Resolution	Test current	Basic uncertainty
10 mA	3.5 mA..20.0 mA	0.1 mA	$0.35 \times I_{\Delta n}..2.0 \times I_{\Delta n}$	$\pm 10 \% I_{\Delta n}$
30 mA	10.5 mA..42.0 mA			
100 mA	35 mA..140 mA	1 mA	$0.35 \times I_{\Delta n}..1.4 \times I_{\Delta n}$	
300 mA	105 mA..420 mA			
500 mA	175 mA..700 mA			

- measurement may be performed for positive or negative half-periods of forced leakage current
- test current duration max. 8,8 s

Measurement of RCD disconnection current I_A for differential direct current

Test range according to IEC 61557-6: $(0.2...2)I_{\Delta n}$

Selected nominal current of RCD	Test range	Resolution	Test current	Basic uncertainty
10 mA	2.0 mA..20.0 mA	0.1 mA	$0.2 \times I_{\Delta n}..2.0 \times I_{\Delta n}$	$\pm 10 \% I_{\Delta n}$
30 mA	6 mA..60 mA	1 mA		
100 mA	20 mA..200 mA			
300 mA	60 mA..600 mA			
500 mA	100 mA..1000 mA			

- measurement can be performed for positive or negative forced leakage current
- test current duration max. 5,2 s

Measurement of resistance-to-earth R_E

Test range according to IEC 61557-5: 0.50 Ω ...1.99 k Ω for test voltage of 50 V
and 0.56 Ω ...1.99 k Ω for test voltage of 25 V

Range	Resolution	Basic uncertainty
0.00 Ω ...9.99 Ω	0.01 Ω	$\pm(2\% \text{ m.v.} + 4 \text{ digits})$
10.0 Ω ...99.9 Ω	0.1 Ω	$\pm(2\% \text{ m.v.} + 3 \text{ digits})$
100 Ω ...999 Ω	1 Ω	
1.00 k Ω ...1.99 k Ω	0.01 k Ω	

- test voltage: 25 V or 50 V rms
- test current: 20 mA, sinusoidal rms 125 Hz (for $f_n=50$ Hz) and 150 Hz (for $f_n=60$ Hz)
- blocking of measurement at interference voltage of $U_N > 24$ V
- maximum measured voltage of interferences $U_{N\max}=100$ V
- maximum resistance of auxiliary earth electrodes 50 k Ω

Measurement of resistance of auxiliary earth electrodes R_H , R_S

Display range	Resolution	Basic uncertainty
000 Ω ...999 Ω	1 Ω	$\pm(5\% (R_S + R_E + R_H) + 3 \text{ digits})$
1.00 k Ω ...9.99 k Ω	0.01 k Ω	
10.0 k Ω ...50.0 k Ω	0.1 k Ω	

Measurement of interference voltages

Internal resistance: about 8 M Ω

Range	Resolution	Basic uncertainty
0 V...100 V	1 V	$\pm(2\% \text{ m.v.} + 3 \text{ digits})$

Selective measurement of earthing with clamps

Range	Resolution	Basic uncertainty *
0.00 Ω ...9.99 Ω	0.01 Ω	$\pm(8\% \text{ m.v.} + 4 \text{ digits})$
10.0 Ω ...99.9 Ω	0.1 Ω	
100 Ω ...999 Ω	1 Ω	
1.00 k Ω ...1.99 k Ω	0.01 k Ω	

* - at maximum interference current 1 A

- Measurement with additional current clamps,
- The range of interference current is up to 9.99 A.

Selective measurement of earthing with two clamps

Range	Resolution	Basic uncertainty *
0.00 Ω ...9.99 Ω	0.01 Ω	$\pm(10\% \text{ m.v.} + 4 \text{ digits})$
10.0 Ω ...19.9 Ω	0.1 Ω	
20.0 Ω ...99.9 Ω		

* - at maximum interference current 1 A

- Measurement with transmitting and receiving clamps.
- The range of interference current is up to 9.99 A.

Measuring soil resistivity (ρ)

Range	Resolution	Basic uncertainty
0.0 Ω m...99.9 Ω m	0.1 Ω m	Depending on the basic uncertainty of the measurement R_E
100 Ω m...999 Ω m	1 Ω m	
1.00 k Ω m...9.99 k Ω m	0.01 k Ω m	
10.0 k Ω m...99.9 k Ω m	0.1 k Ω m	

- Measurement with Wenner method,
- Option for setting the distance in meters or feet,
- Selecting a distance: 1 m ... 30 m (1 ft ... 90 ft).

Low-voltage measurement of continuity of circuit and resistance

Measurement of continuity of protective conductors and equipotential bondings with ± 200 mA current

Measurement range according to IEC 61557-4: 0.12 Ω ...400 Ω

Range	Resolution	Basic uncertainty
0.00 Ω ...19.99 Ω	0.01 Ω	$\pm(2\% \text{ m.v.} + 3 \text{ digits})$
20.0 Ω ...199.9 Ω	0.1 Ω	
200 Ω ...400 Ω	1 Ω	

- Voltage at open terminals: 4 V...9 V
- Output current at $R < 2 \Omega$: min. 200 mA (I_{SC} : 200 mA..250 mA)
- Compensation of test leads resistance
- Measurements for both current polarizations

Measurement of resistance with low current

Range	Resolution	Basic uncertainty
0.0 Ω ...199.9 Ω	0.1 Ω	$\pm(3\% \text{ m.v.} + 3 \text{ digits})$
200 Ω ...1999 Ω	1 Ω	

- Voltage at open terminals: 4...9V
- Output current < 8 mA
- Audio signal for measured resistance < 30 $\Omega \pm 50\%$
- Compensation of test leads resistance

Measurement of insulation resistance

Measurement range, according to IEC 61557-2 for $U_N = 50$ V: 50 k Ω ...250 M Ω

Display range for $U_N = 50$ V	Resolution	Basic uncertainty
0 k Ω ...1999 k Ω	1 k Ω	$\pm(3\% \text{ m.v.} + 8 \text{ digits}),$ $[\pm(5\% \text{ m.v.} + 8 \text{ digits})]^*$
2.00 M Ω ...19.99 M Ω	0.01 M Ω	
20.0 M Ω ...199.9 M Ω	0.1 M Ω	
200 M Ω ...250 M Ω	1 M Ω	

* - for WS-03 and WS-04 leads

Test range according to IEC 61557-2 for $U_N = 100$ V: 100 k Ω ...500 M Ω

Display range for $U_N = 100$ V	Resolution	Basic uncertainty
0 k Ω ...1999 k Ω	1 k Ω	$\pm(3\% \text{ m.v.} + 8 \text{ digits})$ $[\pm(5\% \text{ m.v.} + 8 \text{ digits})]^*$
2.00 M Ω ...19.99 M Ω	0.01 M Ω	
20.0 M Ω ...199.9 M Ω	0.1 M Ω	
200 M Ω ...500 M Ω	1 M Ω	

* - for WS-03 and WS-04 leads

Measurement range, according to IEC 61557-2 for $U_N = 250 \text{ V}$: 250 k Ω ...999 M Ω

Display range for $U_N = 250 \text{ V}$	Resolution	Basic uncertainty
0 k Ω ...1999 k Ω	1 k Ω	$\pm (3 \% \text{ m.v.} + 8 \text{ digits})$ $[\pm(5 \% \text{ m.v.} + 8 \text{ digits})]^*$
2.00 M Ω ...19.99 M Ω	0.01 M Ω	
20.0 M Ω ...199.9 M Ω	0.1 M Ω	
200 M Ω ...999 M Ω	1 M Ω	

* - for WS-03 and WS-04 leads

Measurement range, according to IEC 61557-2 for $U_N = 500 \text{ V}$: 500 k Ω ...2.00 G Ω

Display range for $U_N = 500 \text{ V}$	Resolution	Basic uncertainty
0 k Ω ...1999 k Ω	1 k Ω	$\pm (3 \% \text{ m.v.} + 8 \text{ digits})$ $[\pm(5 \% \text{ m.v.} + 8 \text{ digits})]^*$
2.00 M Ω ...19.99 M Ω	0.01 M Ω	
20.0 M Ω ...199.9 M Ω	0.1 M Ω	
200 M Ω ...999 M Ω	1 M Ω	
1.00 G Ω ...2.00 G Ω	0.01 G Ω	$\pm (4 \% \text{ m.v.} + 6 \text{ digits})$ $[\pm(6 \% \text{ m.v.} + 6 \text{ digits})]^*$

* - for WS-03 and WS-04 leads

Test range according to IEC 61557-2 for $U_N = 1000 \text{ V}$: 1000 k Ω ...9.99 G Ω

Display range for $U_N = 1000 \text{ V}$	Resolution	Basic uncertainty
0 k Ω ...1999 k Ω	1 k Ω	$\pm (3 \% \text{ m.v.} + 8 \text{ digits})$
2.00 M Ω ...19.99 M Ω	0.01 M Ω	
20.0 M Ω ...199.9 M Ω	0.1 M Ω	
200 M Ω ...999 M Ω	1 M Ω	
1.00 G Ω ...9.99 G Ω	0.01 G Ω	$\pm (4 \% \text{ m.v.} + 6 \text{ digits})$

- Test voltage: 50 V, 100 V, 250 V, 500 V i 1000 V
- Accuracy of generated voltage (Robc [Ω] $\geq 1000 \cdot U_N$ [V]): -0 % +10 % from the set value
- Detection of a dangerous voltage before commencing a measurement
- Discharging the object tested
- Measurement of insulation resistance with the use of UNI-Schuko plug (WS-03, WS-04) between all three terminals (for $U_N=1000 \text{ V}$ is not available)
- Insulation resistance measurement for multi-wire cables (max. 5) using an optional external AutoISO-1000c adapter
- Measurement of voltage on terminals +R_{ISO}, -R_{ISO} within the range of: 0 V...440 V
- Test current < 2 mA

Light measurements

Range for LP-1 probe

Range [Ix]	Resolution [Ix]	Spectral uncertainty	Basic uncertainty
0...399,9	0,1	f1 < 6 %	$\pm(5 \% \text{ m.v.} + 5 \text{ digits})$
400...3999	1		
4,00 k...19,99 k	0,01 k		

Range [fc]	Resolution [fc]	Spectral uncertainty	Basic uncertainty
0...39,99	0,01	f1 < 6 %	±(5 % m.v. + 5 digits)
40,0...399,9	0,1		
400...1999	1		

- Probe class B

Range for LP-10B probe

Range [Ix]	Resolution [Ix]	Spectral uncertainty	Basic uncertainty
0...39,99	0,01	f1 < 6 %	±(5 % m.v. + 5 digits)
40,0...399,9	0,1		
400...3999	1		
4,00 k...39,99 k	0,01 k		
40,0 k...399,9 k	0,1 k		

Range [fc]	Resolution [fc]	Spectral uncertainty	Basic uncertainty
0...3,999	0,001	f1 < 6 %	±(5 % m.v. + 5 digits)
4,00...39,99	0,01		
40,0...399,9	0,1		
400...3999	1		
4,00 k...39,99 k	0,01 k		

- Probe class B

Range for LP-10A probe

Range [Ix]	Resolution [Ix]	Spectral uncertainty	Basic uncertainty
0...3,999	0,001	f1 < 2 %	±(2 % m.v. + 5 digits)
4,00...39,99	0,01		
40,0...399,9	0,1		
400...3999	1		
4,00 k...39,99 k	0,01 k		
40,0 k...399,9 k	0,1 k		

Range [fc]	Resolution [fc]	Spectral uncertainty	Basic uncertainty
0...3,999	0,001	f1 < 2 %	±(2 % m.v. + 5 digits)
4,00...39,99	0,01		
40,0...399,9	0,1		
400...3999	1		
4,00 k...39,99 k	0,01 k		

- Probe class A

Phase sequence

- Phase sequence indication: in the same direction (correct), opposite direction (incorrect)
- Range of network voltages U_{L-L} : 95 V...500 V (45 Hz...65 Hz)
- Display of phase-to-phase voltages

Motor rotation

- SEM motor voltage ranges: 1 V + 760 V AC
- Test current (per phase): <3,5 mA

10.2 Other technical data

- a) type of insulationdouble, EN 61010-1 and IEC 61557 compliant
- b) measurement category IV 300 V (III 600 V) according to EN 61010-1
- c) degree of housing protection acc. to EN 60529 IP54
- d) power supply of the meter
alkaline batteries 4x1.5 V LR14 (C) or package of rechargeable batteries SONEL NiMH 4.8 V 4.2 Ah
- e) parameters of AC adapter for the battery charge 100 V...240 V, 50 Hz...60 Hz
- f) dimensions288 mm x 223 mm x 75 mm
- g) weight of the meter with batteries approx. 2.5 kg
- h) storage temperature-20 °C...+70 °C
- i) working temperature0 °C...+50 °C
- j) temperature range suitable for initiating battery charging.....+10 °C to +40 °C
- k) temperatures at which loading is interrupted..... below +5 °C and above (or equal to) +50 °C
- l) humidity 20 %...90 %
- m) nominal temperature.....+23 °C ± 2 °C
- n) reference humidity 40 %...60 %
- o) altitude (above sea level)<2000 m
- p) time settings for automatic shut-down when idle (Auto-OFF)..... 5, 15, 30, 60 min or off
- q) number of measurements Z or RCD (for charged batteries) ..>3000 (6 measurements per minute)
- r) number of measurements R_{ISO} or R (for charged batteries).....>1000
- s) time of recording (for charged batteries) 16 h
- t) display LCD, segment-type
- u) memory of measurement results 10000 records
- v) recorder memory6000 cells
- w) data transmission USB and Bluetooth
- x) quality standarddesign, construction and manufacturing are ISO 9001, ISO 14001, PN-N-18001 compliant
- y) the device meets the requirements of IEC 61557 standard
- z) the product meets EMC requirements (immunity for industrial environment) according to the following standards.....EN 61326-1 and EN 61326-2-2

EN 55022 Compliance statement

MPI-530 / MPI-530-IT is a class A product. In a domestic environment this product may cause radio interference in which case the user may be required to take adequate measures (e.g. increasing the distance between affected products).

10.3 Additional data

Data on additional uncertainties are useful mainly when the meter is used in non-standard conditions and for metrological laboratories for the purpose of calibration.

10.3.1 Additional uncertainties according to IEC 61557-2 (R_{ISO})

Significant parameter	Designation	Additional uncertainty
Position	E ₁	0 %
Supply voltage	E ₂	0 %
Temperature 0 °C...35 °C	E ₃	2 %

10.3.2 Additional uncertainties according to IEC 61557-3 (Z)

Significant parameter	Designation	Additional uncertainty
Position	E ₁	0 %
Supply voltage	E ₂	0 %
Temperature 0 °C...35 °C	E ₃	1.2 m lead – 0 Ω 5 m lead – 0.011 Ω 10 m lead – 0.019 Ω 20 m lead – 0.035 Ω WS-03 and WS-04 lead – 0.15 Ω
Phase angle 0° .. 30°	E _{6,2}	0,6 %
Frequency 99 %..101 % f _n	E ₇	0 %
Mains voltage 85 %..110 % U _n	E ₈	0 %
Harmonic	E ₉	0 %
DC component	E ₁₀	0 %

10.3.3 Additional uncertainties according to IEC 61557-4 (R ±200 mA)

Significant parameter	Designation	Additional uncertainty
Position	E ₁	0 %
Supply voltage	E ₂	0.5 %
Temperature 0 °C...35 °C	E ₃	1.5 %

10.3.4 Additional uncertainties of earth resistance measurement (R_E)

Additional uncertainties according to IEC 61557-5

Significant parameter	Designation	Additional uncertainty
Position	E ₁	0 %
Supply voltage	E ₂	0 %
Temperature 0 °C...35 °C	E ₃	0 % for 50 V ± 2 digits for 25 V
Serial interference voltage	E ₄	±(6.5 % + 5 digits)
Resistance of electrodes	E ₅	2.5 %
Frequency 99 %..101 % f _n	E ₇	0 %
Mains voltage 85 %..110 % U _n	E ₈	0 %

Additional uncertainty caused by serial interference voltage for 3p, 4p, 3p+clamps functions

(for 25 V and 50 V)

R _E	Additional uncertainty
<10 Ω	$\pm(((-32 \cdot 10^{-5} \cdot R_E + 33 \cdot 10^{-4}) \cdot U_Z^2 + (-12 \cdot 10^{-3} \cdot R_E + 13 \cdot 10^{-3}) \cdot U_Z) \cdot 100\% + 0,026 \cdot \sqrt{U_Z \Omega})$
≥10 Ω	$\pm(((-46 \cdot 10^{-9} \cdot R_E + 1 \cdot 10^{-4}) \cdot U_Z^2 + (14 \cdot 10^{-8} \cdot R_E + 19 \cdot 10^{-5}) \cdot U_Z) \cdot 100\% + 0,26 \sqrt{U_Z \Omega})$

Additional uncertainty caused by resistance of electrodes

$$\delta_{dod} = \pm \left(\frac{R_S}{R_S + 10^6} \cdot 300 + \frac{R_H^2}{R_E \cdot R_H + 200} \cdot 3 \cdot 10^{-3} + \left(1 + \frac{1}{R_E} \right) \cdot R_H \cdot 5 \cdot 10^{-4} \right) [\%]$$

Formula is valid for R_S > 200 Ω and/or R_H ≥ 200 Ω.

Additional uncertainty due to interference current for 3p + clamps function

(for 25 V and 50 V)

R_E	Uncertainty [Ω]
$\leq 50 \Omega$	$\pm (4 \cdot 10^{-2} \cdot R_E \cdot I_{zakl}^2)$
$> 50 \Omega$	$\pm (25 \cdot 10^{-5} \cdot R_E^2 \cdot I_{zakl}^2)$

Additional uncertainty due to interference current for double clamps function

R_E	Uncertainty [Ω]
$< 5 \Omega$	$\pm (5 \cdot 10^{-2} \cdot R_E^2 \cdot I_{zakl})$
$\geq 5 \Omega$	$\pm (2,5 \cdot 10^{-2} \cdot R_E^2 \cdot I_{zakl}^2)$

Additional uncertainty for the ratio of the resistance measured with clamps on a branch of a multiple earthing, to the resultant resistance the as a function of 3p + clamps.

R_C	Uncertainty [Ω]
$\leq 99.9 \Omega$	$\pm (5 \cdot 10^{-3} \cdot \frac{R_C}{R_W^2})$
$> 99.9 \Omega$	$\pm (9 \cdot 10^{-2} \cdot \frac{R_C}{R_W^2})$

$R_C[\Omega]$ is a value of resistance measured with clamps on the branch displayed by the device, whereas $R_W[\Omega]$ is a value of resultant resistance of multiply earthing.

10.3.5 Additional uncertainties according to IEC 61557-6 (RCD)

I_A, t_A, U_B

Significant parameter	Designation	Additional uncertainty
Position	E_1	0 %
Supply voltage	E_2	0 %
Temperature 0 °C...35 °C	E_3	0 %
Resistance of electrodes	E_5	0 %
Mains voltage 85 %..110 % U_n	E_8	0 %

10.4 List of reference standards

EN 61010-1:2011
 EN 61557-1:2009,-2, 3, 4, 5, 7:2007, -6:2008, -10:2004
 EN 60529:2003
 EN 61326-1:2009
 EN 61326-2-2:2006
 EN ISO 9001:2009/AC:2009

11 Accessories

The current list of accessories can be found on the manufacturer's website.

11.1 Standard accessories

Standard set of equipment supplied by the manufacturer includes:

- MPI-530 / MPI-530-IT meter
- set of test leads:
 - Uni-Schuko cable with measurement trigger function (Cat. III 300 V) – WS-03 – **WAADAWS03**
 - 1.2 m leads, cat. III 1000 V with banana plugs – 3 pcs (yellow – **WAPRZ1X2YEBB**, red – **WAPRZ1X2REBB** and blue - **WAPRZ1X2BUBB**)
 - 15m-long test leads on reels (**WAPRZ015BUBBSZ** blue) and 30 m-long test lead (**WAPRZ030REBBSZ** red)
- crocodile clip. cat. III 1000 V – 3 pcs (yellow K02 – **WAKROYE20K02**, red K02 - **WAKRORE20K02**, blue K02 – **WAKROBU20K02**)
- test prod with banana socket. cat. III 1000 V – 3 pcs (yellow – **WASONYEOGB1**, red – **WASONREOGB1** and blue – **WASONBUOGB1**)
- earth contact test probe (rod) 30 cm – 2 probes – **WASONG30**
- Z7 charger – **WAZASZ7**
- adapter cable (230 V) – **WAPRZLAD230**
- cable for charging the battery pack from the car cigarette lighter socket –**WAPRZLAD12SAM**
- carrying case for the meters and accessories – **WAFUTL2**
- hanging straps for the meter (long: 1.5 m and short: 30 cm) – **WAPOZSZEKPL**
- USB cable – **WAPRZUSB**
- user manual
- calibration certificate
- NiMH 4.8 V 4.2 Ah rechargeable battery pack – **WAAKU07**

11.2 Optional accessories

Additionally, the following items that are not included in the scope of standard equipment may be purchased from the manufacturer or the distributors:

WAADAWS04



- test lead with angle plug (without triggering) WS-04

WAPRZ050YEBBSZ



- 50m test lead

WACEGC6OKR



- receiver clamps C-6

WACEGC3OKR



- receiver clamps C-3

WAADAAISO10C



- AutoISO-1000C adapter

WAPRZ025BUBBSZ



- 25m test lead

WAPRZ005REBB



- cable with banana plugs -5 m (10 m - WAPRZ010REBB, 20 m - WAPRZ020REBB)

WAADAAGT16P – five-wire version

WAADAAGT16C – four-wire version



- AGT-16P or C (16A) adapter for three-phase sockets

WACEGN1BB



- transmitter clamps N-1

WACEGF1OKR



- flexible clamps F-1 Ø 40 cm (F-2 Ø 25 cm WACEGF2OKR, F-3 Ø 13 cm WACEGF3OKR)

WAADALP1KPL - set for MPI-530

WAADALP1 – only probe with PS/2 plug

WAADAWS06 – only WS-06 adapter with PS/2 socket



- probe of LP-1 luxmeter with WS-06 plug, class B, resolution from 0,1 lx

WAADALP10AKPL - set for MPI-530

WAADALP10A – only probe with PS/2 plug

WAADAWS06 – only WS-06 adapter with PS/2 socket



probe of LP-10A luxmeter with WS-06 plug, class A, resolution from 0,001 lx

WAADAAGT32P – five-wire version

WAADAAGT32C – four-wire version



- AGT-32P or C (32A) adapter for three-phase sockets

WAADAAGT63P – five-wire version



- AGT-63P (63A) adapter for three-phase sockets

WAADALP10BKPL - set for MPI-530

WAADALP10B – only probe with PS/2 plug

WAADAWS06 – only WS-06 adapter with PS/2 socket



- probe of LP-10B luxmeter with WS-06 plug, class B, resolution from 0,01 lx

WAADAAGT16T



- AGT-16T (16A) adapter for single-phase industrial sockets

WAADATWR1J



- RCD testing adapter TWR-1J

WAPROREPORTPLUS



- Software Sonel Reports Plus. Supports creation of documentation after testing of electrical installation.

WAPOJ1



- battery compartment

WAADAAGT32T



- AGT-32T (32A) adapter for single-phase industrial sockets

WAADAMKZ – k set for MPI-530

WAADAMK – only the keyboard

WAFUTS4 – only the case for the keyboard



- Miniature Bluetooth keyboard with case
- Calibration certificate with accreditation

Note

The software is supported by the following systems: Windows XP (Service Pack 2), Windows Vista and Windows 7.

11.2.1 Clamps C-3

Clamps C-3 are used to measure AC in electrical systems of low and medium power. As optional accessories for instruments produced by Sonel S.A., they are compatible with earth resistance meters of MRU series and multifunctional meters of MPI series.

The output signal is conducted by a cable (1.5 m) ended with a pin adapted to the socket on the meter.

Attention!
Do not measure currents exceeding 1200A. Limit the measurement time for currents higher than 1000A, according to the following data.

Overloads:

Current Range	$I \leq 1000A$	$1000A < I \leq 1200A$
Operating mode	continuous ¹⁾	15 minutes of measurement, followed by 30-minute break

¹⁾ For frequencies $f \leq 1kHz$. Limiting the maximum current in continuous operation for frequencies above 1kHz according to the ratio:

$$I_{cont} = 1000A/f[kHz]$$

Terms of reference:

- Temperature +20...+26°C
- Relative Humidity 20...75%
- Conductor centred in the jaws
- Frequency of sinusoidal current 48...65Hz
- Total harmonic distortion <1%
- Current constant component none
- Constant magnetic field <40A/m (Earth's magnetic field)
- Variable, external magnetic field none
- Conductors in the immediate vicinity no current flow

Technical specifications:

Current Range	Basic uncertainty ¹⁾	Phase error
10...100mA	$\leq 3\% + 5mA$	unspecified
0,1A...1A	$\leq 3\% + 3mA$	unspecified
1A...10A	$\leq 1\%$	$\leq 2^\circ$
10A...100A	$\leq 0.5\%$	$\leq 1^\circ$
100...1200A	$\leq 0.3\%$	$\leq 0,7^\circ$

¹⁾ as % of the measured value

- output for maximum power 1A AC
- ratio 1000/1
- frequency range 30Hz...10kHz

Other data:

- a) type of insulation double, according to EN 61010-1
- b) measurement category according to EN 61010-1 III 600V
- c) degree of housing protection acc. to EN 60529 IP40, with open jaws: IP30
- d) dimensions 216 × 111 × 45mm
- e) weight approx. 550g
- f) jaws opening distance 53mm
- g) height of open jaws 139mm
- h) maximum diameter of tested cable $\varnothing 52mm$

- i) length of clamp cables..... 1.5 m
- j) working temperature..... -10°C... +55°C
- k) Relative Humidity <85%
- l) height ≤ 2000mm
- m) quality standard... design, construction and manufacturing are ISO 9001, ISO 14001, PN-N-18001 compliant
- n) the product meets EMC requirements acc. to.....EN 61000-6-3 and EN 61000-6-2

11.2.2 Clamps C-6

Clamps C-6 are designed to measure AC currents with frequencies up to 10kHz for range 10mA ... 10A. As optional accessories for instruments produced by Sonel S.A., they are compatible with power quality meters of PQM series and multifunctional meters of MPI series.

The output signal is a voltage proportional to the measured current at the sensitivity of 100mV/A. It is introduced via a cable (length: 1.5 m) ended with a plug suitable for a socket in the meter.

The arrow marked on one of the clamps indicates the direction of current flow. It is assumed that the current flows in the positive direction if it flows from the source to the receiver. This orientation of clamps is required for the correct power measurement.

ATTENTION!
Do not use non-insulated clamps for conductors with a potential exceeding 600V with respect to the ground, in systems with the measurement category higher than III and systems of measurement category IV with potential exceeding 300V.

Terms of reference:

- Temperature +20... +26°C
- Relative Humidity..... 20... 75%
- Conductor..... centred in the jaws
- Frequency of sinusoidal current..... 48... 65Hz
- Total harmonic distortion <1%
- Current constant component..... none
- Constant magnetic field <40A/m (Earth's magnetic field)
- Variable, external magnetic field..... none
- Conductors in the immediate vicinity..... no current flow

Technical specifications:

Current Range	Basic uncertainty ¹⁾	Phase error
0.01 ... 0.1 A	≤ 3% + 1mA	unspecified
0.1 ... 1A	≤ 2.5%	≤ 5°
1... 12A	≤ 1%	≤ 3°

¹⁾ as % of the measured value

- ratio 100mV AC/1A AC
- frequency range..... 40Hz... 10kHz

Other data:

- a) type of insulation double, according to EN 61010-1
- b) measurement category according to EN 61010-1..... III 600V
- c) degree of housing protection acc. to EN 60529 IP40, with open jaws: IP30
- d) dimensions 135 × 50 × 30mm
- e) weight..... approx. 180g
- f) jaws opening distance 21mm
- g) height of open jaws..... 69mm
- h) maximum diameter of tested cable..... Ø20mm

- i) length of clamp cables 1.5 m
- j) working temperature -10°C...+55°C
- k) Relative Humidity <85%
- l) height ≤ 2000m
- m) quality standard ... design, construction and manufacturing are ISO 9001, ISO 14001, PN-N-18001 compliant
- n) the product meets EMC requirements acc. to EN 61000-6-3 and EN 61000-6-2

11.2.3 Clamps F-1, F-2, F-3

Flexible clamps (Rogowski coil) F-1, F-2 and F-3 are designed to measure AC currents with frequencies up to 10kHz for range 1A...3000A. As optional accessories for instruments produced by Sonel S.A., they are compatible with power quality meters of PQM series and with earth resistance meters of MRU series.

Flexible clamps F-1, F-2 and F-3 are different only in terms of the coil perimeter (see technical specifications). Electrical parameters are the same.

The output signal is voltage proportional to the measured current derivative at the sensitivity of 38.83 mV/1000A for 50Hz and 46.6 mV/1000A for 60Hz.

The output signal is conducted by a cable (2 m) ended with a pin adapted to the socket on the meter.

The arrow marked on one of the clamps indicates the direction of current flow. It is assumed that the current flows in the positive direction if it flows from the source to the receiver. This orientation of clamps is required for the correct power measurement.

ATTENTION!
Do not use non-insulated clamps for conductors with a potential exceeding 1000V with respect to the ground, in systems with the measurement category higher than III and systems of measurement category IV with potential exceeding 300V.

Terms of reference:

- Temperature +20...+22°C
- Conductor centred in the jaws
- Constant magnetic field <40A/m (Earth's magnetic field)
- Variable, external magnetic field none
- External electric field none

Technical specifications:

- a) Nominal measuring range 1A ... 3000A (10000A peak at 50Hz)
- b) Input / output ratio 38.83mV/1000A (50Hz)
 46.6 mV/1000A (60Hz)
- c) Basic uncertainty ±1% within the range of 1A...3000A
- d) Linearity ± 0.2%
- e) Additional error due to the position of the conductor ±2% max.
- f) Additional error due to external magnetic field ±0.5% max.
- g) Additional error due to temperature ± 0.07%
- h) Output impedance 30Ω/400mm

Other data:

- a) type of insulation double, according to EN 61010-1
- b) measurement category according to EN 61010-1 III 1000V
- c) degree of housing protection acc. to EN 60529 IP65
- d) coil diameter 15.5 mm
- e) diameter of the clamps (maximum) 30mm
- f) coil perimeter F-1: 120cm
 F-2: 80cm

- F-3: 45cm
- g) inner diameter of clamps after closing F-1: 360mm
..... F-2: 235mm
..... F-3: 120mm
- h) weight F-1: approx. 410g
..... F-2: approx. 310g
..... F-3: approx. 220g
- i) length of clamp cables 2m
- j) working temperature -20°C...+80°C
- k) quality standard... design, construction and manufacturing are ISO 9001, ISO 14001, PN-N-18001 compliant
- l) the product meets EMC requirements acc. toEN 61000-6-3 and EN 61000-6-2

11.2.4 Clamps N-1

Clamps N-1, as optional accessories for instruments produced by Sonel S.A., are compatible with earth resistance meters of MRU series and are designed to be signal transmitting clamps in double-clamp measurements.

The output signal is transmitted via two banana plugs.

Overloads:

Current Range	$I \leq 1000A$	$1000A < I \leq 1200A$
Operating mode	continuous 1	15 minutes of measurement, followed by 30-minute break

1) For frequencies $f \leq 1kHz$. Limiting the maximum current in continuous operation for frequencies above 1kHz according to the ratio:

$$I_{cont} = 1000A/f[kHz]$$

Terms of reference:

- Temperature+20...+26°C
- Relative Humidity20...75%
- Conductorcentred in the jaws
- Current constant component none
- Constant magnetic field <40A/m (Earth's magnetic field)
- Variable, external magnetic field none
- Conductors in the immediate vicinity no current flow

Technical specifications:

- a) output for maximum power 1A AC
- b) ratio 1000/1
- c) frequency range 30Hz...10kHz
- d) type of insulationdouble, according to EN 61010-1
- e) measurement category according to EN 61010-1 III 600V
- f) degree of housing protection acc. to EN 60529IP40, with open jaws: IP30
- g) dimensions 216 × 111 × 45mm
- h) weight approx. 550g
- i) jaws opening distance 53mm
- j) height of open jaws 139mm
- k) maximum diameter of tested cable Ø52mm
- l) working temperature -10°C...+55°C
- m) Relative Humidity <85%
- n) height ≤ 2000m
- o) quality standard... design, construction and manufacturing are ISO 9001, ISO 14001, PN-N-18001 compliant
- p) the product meets EMC requirements acc. toEN 61000-6-3 and EN 61000-6-2

12 Positions of the meter's cover

The movable cover enables using the meter in various positions.

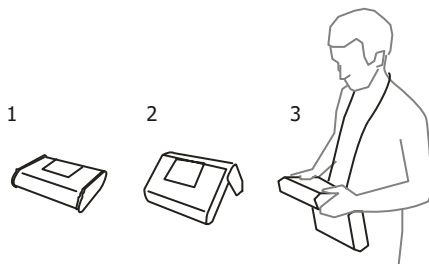

1 – Cover as the bottom of the meter

2 – Cover used as a support

3 – Cover in the position that enables convenient use of the meter suspended on the neck by means of hanging straps

13 Manufacturer

The manufacturer of the device and provider of guarantee and post-guarantee service:

SONEL S.A.

Wokulskiego 11

58-100 Świdnica

Poland

tel. +48 74 858 38 60

fax +48 74 858 38 09

E-mail: export@sonel.pl

Web page: www.sonel.pl

Note:

Service repairs must be performed only by the manufacturer.

14 Laboratory services

SONEL Testing and Calibration Laboratory has been accredited by the Polish Center for Accreditation (PCA) - certificate no. AP 173.

Laboratory offers calibration for the following instruments that are used for measuring electrical and non-electrical parameters.



AP 173

● METERS FOR MEASUREMENTS OF ELECTRICAL PARAMETERS

- voltage meters,
- current meters (including clamp meters),
- resistance meters,
- insulation resistance meters,
- earth resistance and resistivity meters,
- RCD meters,
- short-circuit loop impedance meters,
- power quality analyzers,
- portable appliance testers (PAT),
- power meters,
- multimeters,
- multifunction meters covering the functions of the above-mentioned instruments,

● ELECTRICAL STANDARDS

- calibrators,
- resistance standards,

● METERS FOR MEASUREMENTS OF NON-ELECTRICAL PARAMETERS

- pyrometers,
- thermal imagers,
- luxmeters.

The Calibration Certificate is a document that presents a relation between the calibration standard of known accuracy and meter indications with associated measurement uncertainties. The calibration standards are normally traceable to the national standard held by the National Metrological Institute.

According to ILAC-G24 „Guidelines for determination of calibration intervals of measuring instruments”, SONEL S.A. recommends periodical metrological inspection of the instruments it manufactures no less frequently than once every 12 months.

For new instruments provided with the Calibration Certificate or Validation Certificate at the factory, re-calibration should be performed within 12 months from the date of purchase, however, no later than 24 months from the date of purchase.

ATTENTION !

The person performing the measurements should be absolutely sure about the efficiency of the device being used. Measurements made with an inefficient meter can contribute to an incorrect assessment of the effectiveness of health protection and even human life.







NOTES

WARNINGS AND GENERAL INFORMATION DISPLAYED BY THE METER

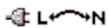
ATTENTION!

MPI-530 meter is designed to operate at the rated phase voltages of 110 V, 115 V, 127 V, 220 V, 230 V and 240 V and phase-to-phase voltages 190 V, 200 V, 220 V, 380 V, 400 V and 415 V.

Connecting voltage higher than allowed between any of the terminals may damage the meter and cause a hazard to the user.

L-N!	U_{L-N} voltage is incorrect for making a measurement.
L-PE!	U_{L-PE} voltage is incorrect for making a measurement.
N-PE!	U_{N-PE} voltage exceeds allowable value of 50 V.
	Phase connected to terminal N instead of L.
	Temperature exceeded.
f!	Network frequency is outside the range of 45 Hz...65 Hz.
Error during measure	A correct result can not be displayed.
Loop circuit malfunction!	The meter should be serviced.
No U_{L-N}!	No U_{L-N} voltage before the main measurement.
Aborted!	The measurement cancelled with ESC .
$U > 500V!$ and continuous audio signal	Voltage at test terminals exceeds 500 V, before the measurement.
$U_N > 50V!$ and continuous audio signal	Voltage at test terminals is higher than 50 V, R_E measurement is blocked.
$U_N!$	Voltage at test terminals is higher than 24 V but lower than 50 V, R_E measurement is blocked.
LIMIT!	Measurement uncertainty R_E due to the resistance of the electrodes > 30 %.
	Interruption in measuring circuit R_E or resistance of test probes is higher than 60 k Ω .
$I_L > \max$	Interference current of measuring clamps is too high. The measurement may be affected by additional uncertainty.
PE! and continuous audio signal	Voltage between the contact electrode and PE conductor exceeds the allowable limit value of U_L .
!	Displayed on the right side of the result indicates a fault of RCD.
$U_E > U_L!$	The touch voltage exceeds a preset U_L threshold value.
	Test voltage is present on terminals of the meter during R_{ISO} measurements.
NOISE!	Signal interferences are too high. The measurement may be affected by additional uncertainty.
LIMIT II!	Activation of current limit during R_{ISO} measurements.
	Status of batteries/rechargeable batteries: Batteries//rechargeable batteries charged. Batteries/accumulators discharged. Batteries/rechargeable batteries fully discharged.
 (on the main field)	Batteries/rechargeable batteries fully discharged. Replace or recharge the batteries.



SONEL S.A.
Wokulskiego 11
58-100 Swidnica
Poland



+48 74 858 38 60
+48 74 858 38 00
fax +48 74 858 38 09

e-mail: export@sonel.pl
www.sonel.pl